



The Long Island Rail Road

MAPS OF FREIGHT STATIONS & PRIVATE SIDINGS

(not to scale)

Revised OCTOBER 1978

Issued by
Manager-Freight Customer Services
P.O. Box 1508
Long Island City, N.Y. 11101

<u>Freight Station</u>	<u>Page No.</u>	<u>Freight Station</u>	<u>Page No.</u>	<u>Freight Station</u>	<u>Page No.</u>	<u>Freight Station</u>	<u>Page No.</u>
Babylon	22	Garden City	35	Malverne	19	Sayville	25
Bayport	25	Glendale	12	Maspeth	8	Sea Cliff	37
Bay Shore	23	Atlas Term.	12A	Mattituck	61	Setauket	47
Bethpage	49	Glen Head	37	Medford	56	Smithtown	46
Blissville	6	Great Neck	15	Mineola	34	Southampton	29
Brentwood	54	Greenlawn	43	New Hyde Park	33	Southold	62
Bridgehampton	30	Hampton Bays	29	Nichols Siding	7	Speonk	27
Bushwick	10, 11	Hicksville	40	Old Northport	44	Stony Brook	47
Calverton	58	Holtsville	56	Oyster Bay	38	Syosset	41
Central Islip	55	Huntington	42	Patchogue	26	Upton	57
Corona	14	Islip	24	Port Jefferson	48	Valley Stream	18
Cutchogue	61	Jamaica	16, 17	Queens Village	31	Westbury	39
Deer Park	53	Jamesport	60	Quogue	28	Westhampton	28
Eastport	27	Kings Park	45	Richmond Hill	16	West Hempstead	19
Elmhurst	14	Locust Valley	37	Riverhead	59	Winfield	13
Farmingdale	50, 51	Long Beach	20	Rockville Centre	21	Wyandanch	52
Floral Park	32	Long Island City	1, 2	Ronkonkoma	56	Yaphank	57
Freeport	21	Degnon Term.	3	Roslyn	36		
Fresh Pond	9	Kearney	5	St. James	46		
		Murrers Sdg.	4				

September, 1978

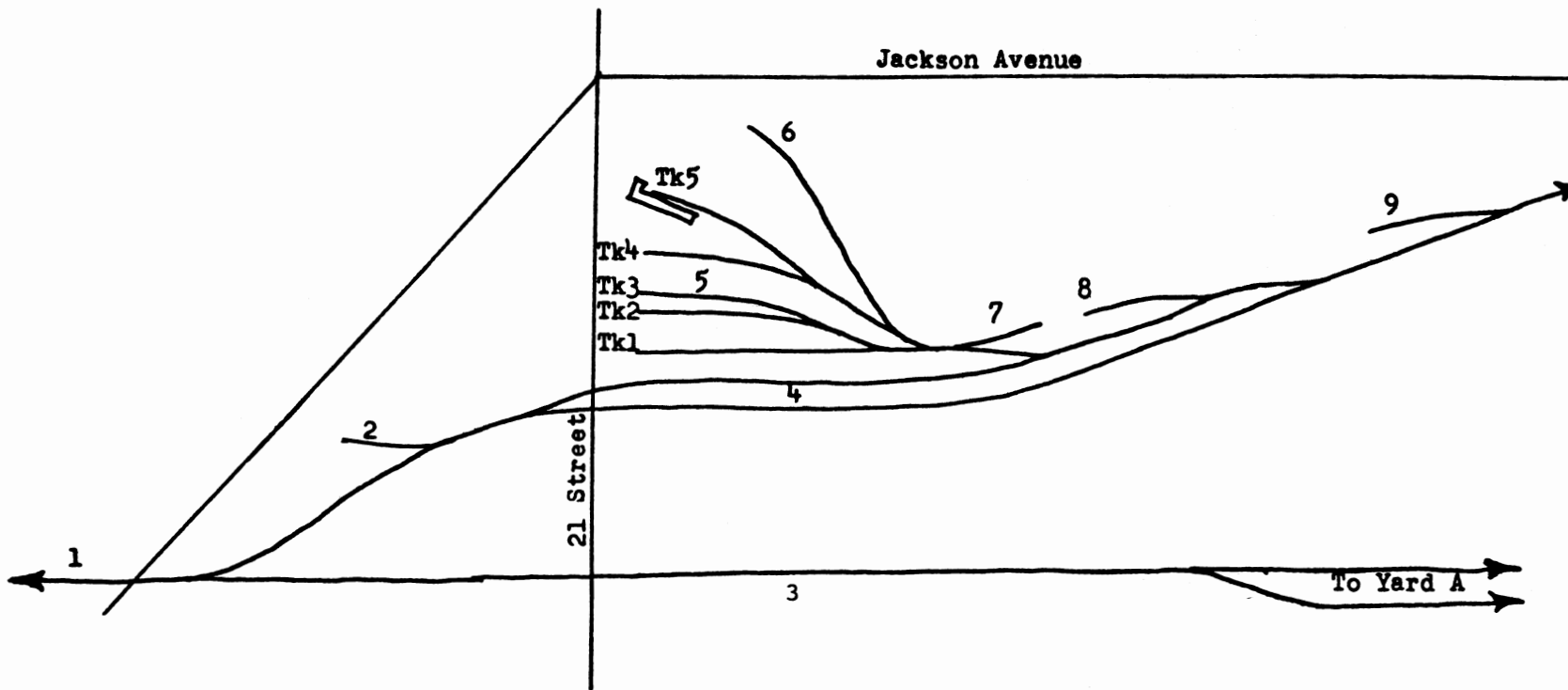

- 1.
- 2. Stein Hall 2
- 3. International Salt 20
- 4. Track Scale
- 5. Team Track 38
 (End Loading Platform 2)

- 6.
- 7.
- 8. Sternberger-Esbit 2
 (International Crating & Container)
- 9. P. F. Mallon
 (Out of Service)

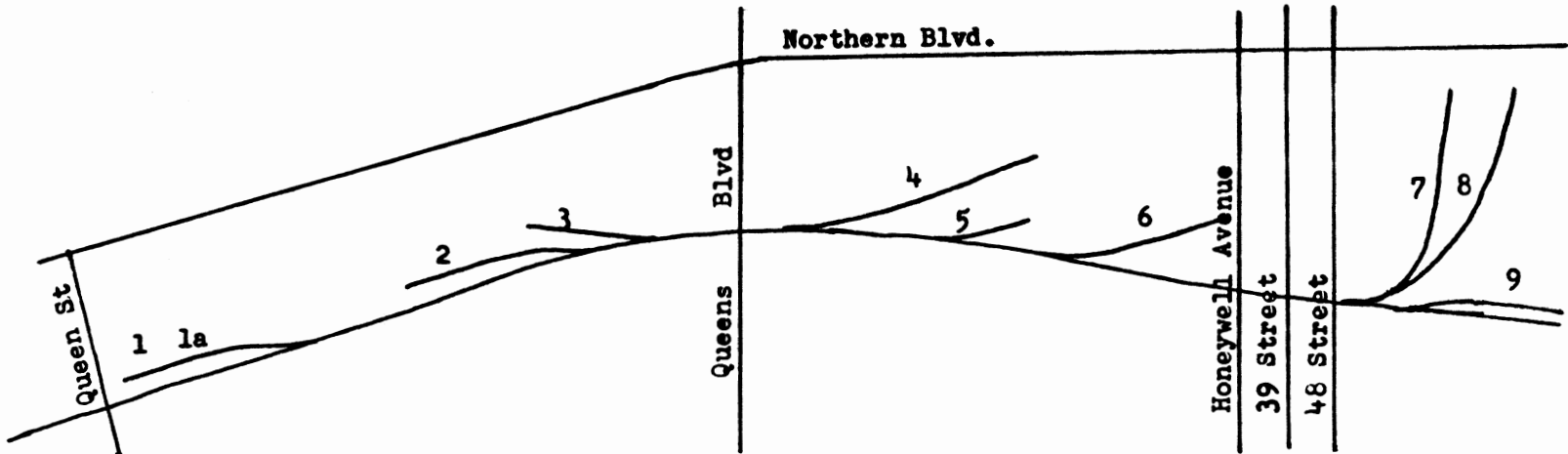

LONG ISLAND CITY

- | | | | |
|---------------------------|---|---------------------|---|
| 1. American Steel Wool | 1 | 5. | |
| 1a. Greenpoint Terminal | 2 | 6. Lek Industries | 1 |
| 2. West Chemical Prod | 3 | 7. Gallo Wine | 6 |
| 3. West Chemical Prod | 1 | 8. General Electric | 4 |
| 4. Superior Reed & Rattan | | 9. Ronzoni | 6 |

8-23-78

DEGNON TERMINAL

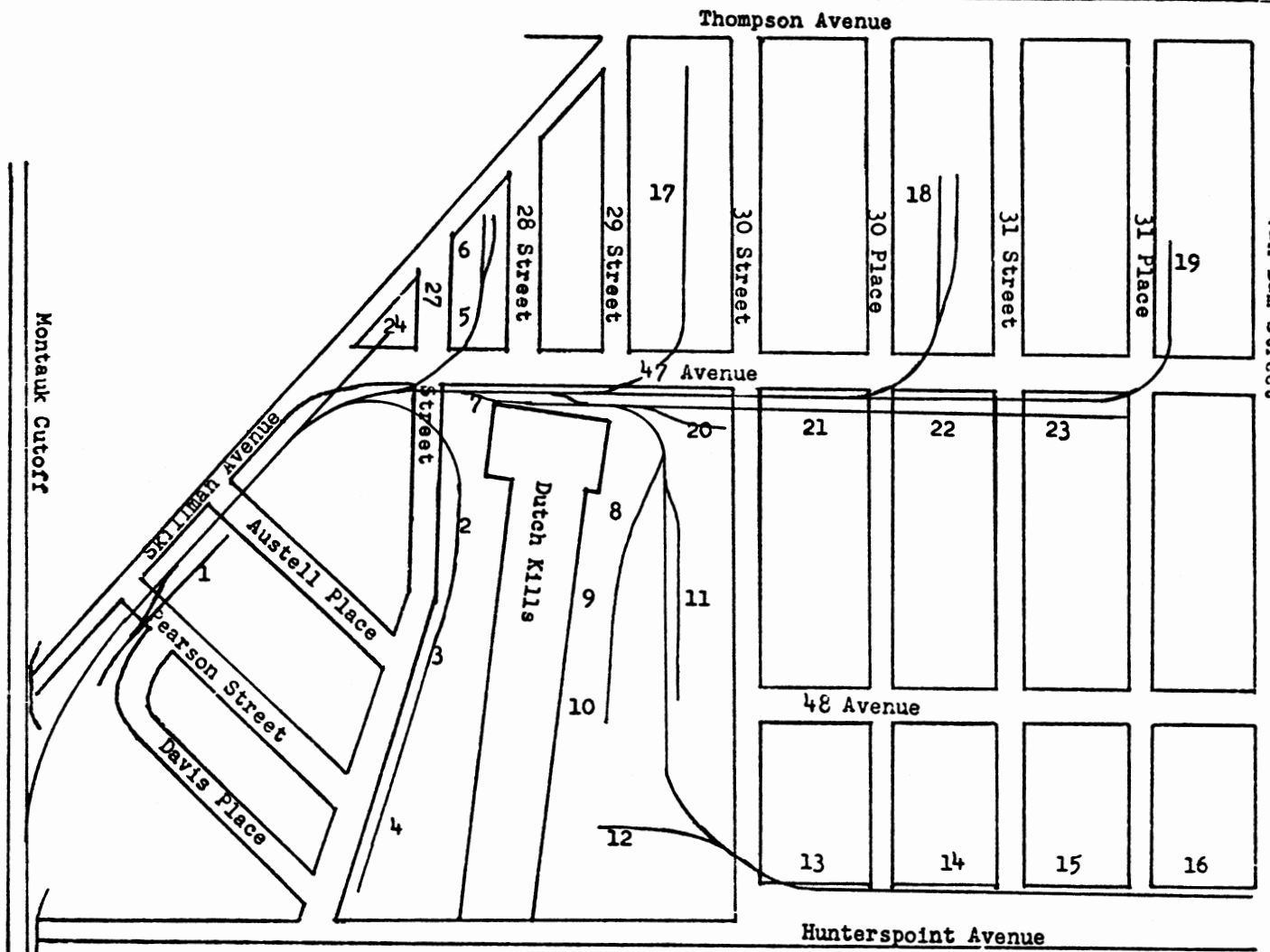

1*	Moldtronics	1
2	Formulette	1
3		
4	Russtogs	1
5	Masbrook Whse	4
6	Ecological Cont.	1
7	Principe Danna	2
8	Masbrook Whse	2
9		
10	J. H. Rhodes	1
11	P. A. Hunt	9
12	Hunterspoint Steel	3
13		
14	New York Envelope	2
15	Andrews, Nelson, Whitehead	1
16	Viking Criterion	2
17	LIC Mart, A. Klein Gimbels	4
18	American Chicle	3
19	Equitable Bag	5
20	P. A. Hunt	1
21		
22		
23	Gimbels	2
24*		

* Track Obstructed

9-1-78

KEARNY SIDING

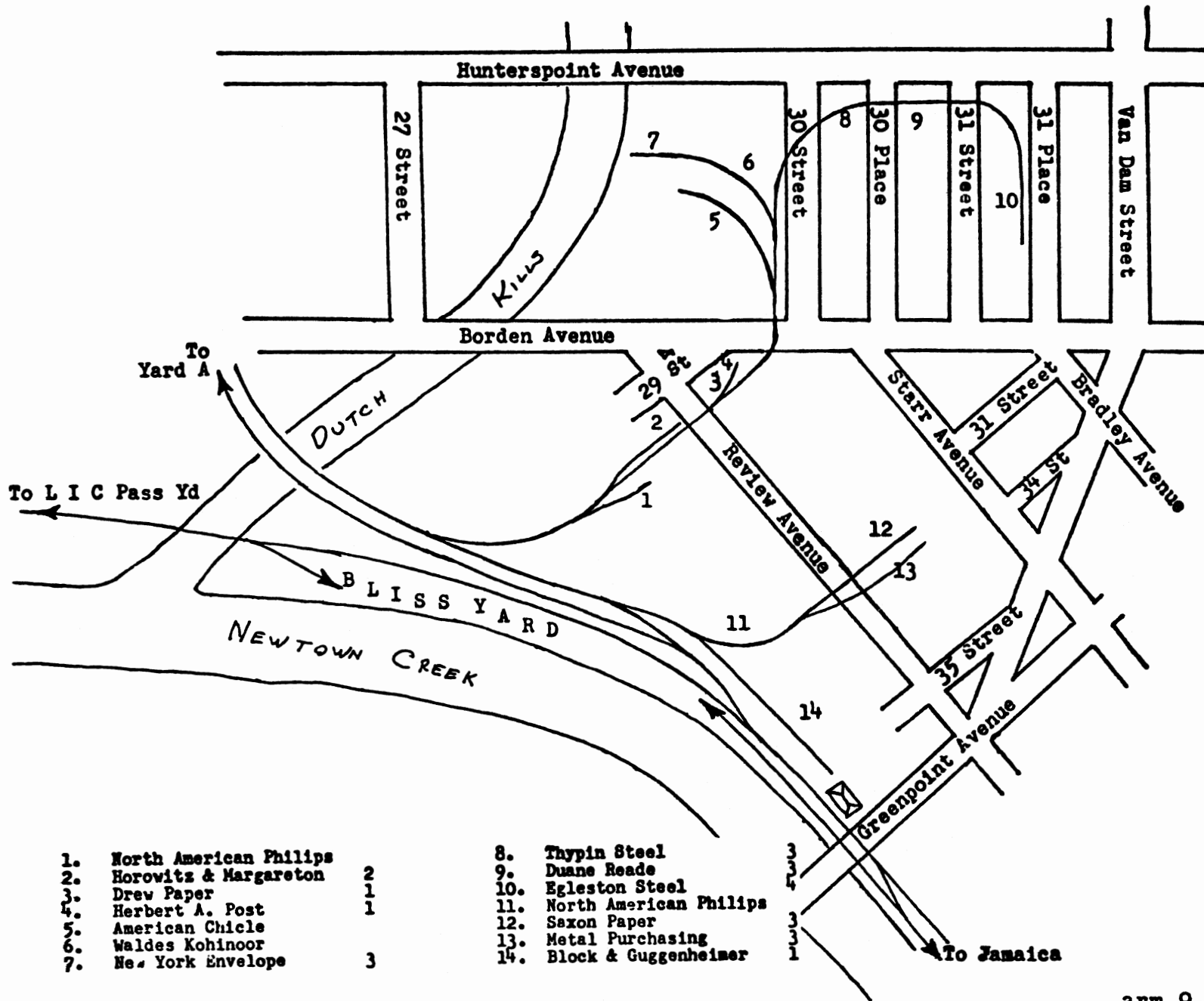

- | | | |
|---------------------------|---|----------------------------|
| 1. North American Philips | | 8. Thylin Steel |
| 2. Horowitz & Margareton | 2 | 9. Duane Reade |
| 3. Drew Paper | 1 | 10. Egleston Steel |
| 4. Herbert A. Post | 1 | 11. North American Philips |
| 5. American Chiclé | | 12. Saxon Paper |
| 6. Waldes Kohinoor | | 13. Metal Purchasing |
| 7. Ne. York Envelope | 3 | 14. Block & Guggenheimer |

BLISSVILLE

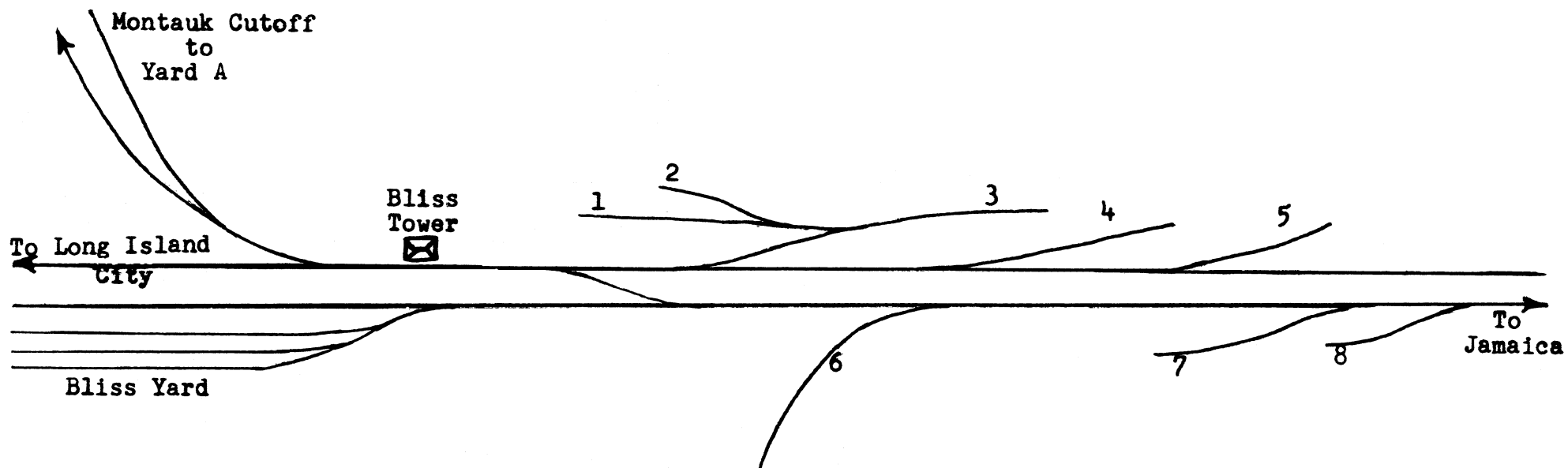

<u>Map Ref.</u>	<u>Consignee</u>	<u>Siding Capacity</u>
1.	Allied Extruders	2
2.	Allied Extruders / Broadway Salvage/ Nanco Contracting	2
3.	Triplex Oil	
4.	Guinness Harp	2
5.	Board of Education / Standard Folding Box	2
6.		
7.	Peerless Oil & Chem.	8
8.	Marlyn Warehouse	3

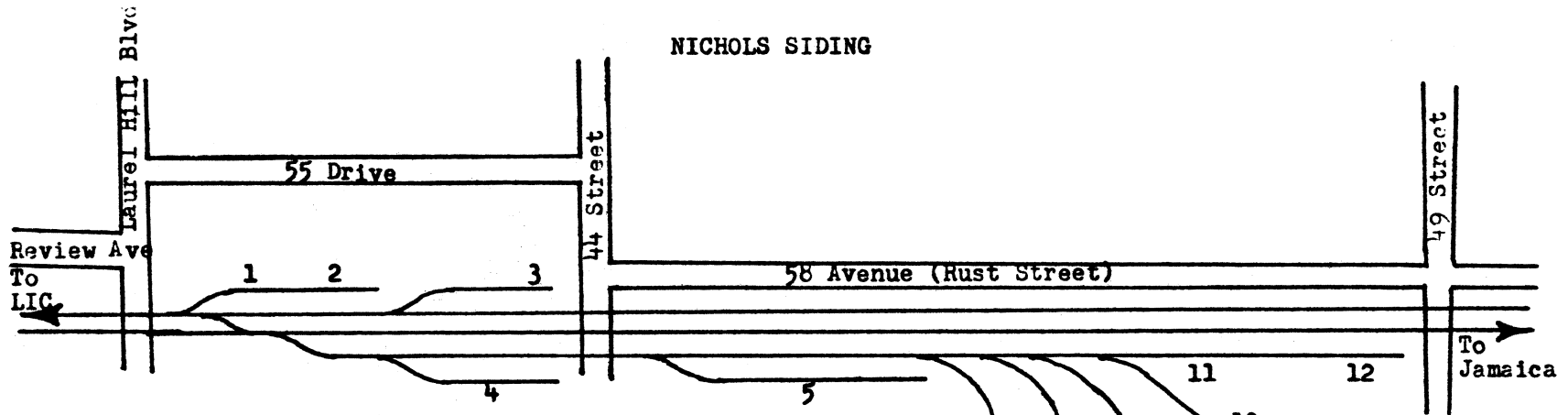

- | | | |
|-----|---------------------------|---|
| 1. | Obes Trucking | |
| 2. | Carroll McCreary | 2 |
| 3. | General Chemical | 2 |
| 4. | | |
| 5. | Phelps Dodge (New Copper) | 8 |
| 6. | Phelps Dodge (Slag #1) | 8 |
| 7. | Phelps Dodge (Slag #2) | 9 |
| 8. | Phelps Dodge (Slag #3) | 8 |
| 9. | Phelps Dodge (N.Platform) | 5 |
| 10. | Phelps Dodge (S.Platform) | 5 |
| 11. | Acme Excelsior | 1 |
| 12. | Greenpoint Terminal Whse | 2 |
| 13. | Davis & Warshow | 1 |
| 14. | Pet Food | 2 |

MASPETH

Map Ref.	Consignee	Siding Capacity
1.	Schaefer Beer	4
2a		4
2b		4
2c		3
2d	Bloomingdale's	5
3.	Bulkley Dunton LL	3
4.		
5.		
6.	Mfrs. Corr. Box	3
7.		3
8.	Boro Hall Lumber	1
9.	Dae Trucking	9
10.	Cerro Wire (new)	2
11.	Cerro Wire (old)	
12.		
13a	Starr Corrugated	6 Long
13b	Starr Corrugated	4 Short
14.	Plywood Distr.	2
15.	Team Track 1-5	60
16.	Janine Paper & Bag	
17.		10
18.	Alfred Bleyer	3
19.	Howard Rubber	2
20.		
21.		
22.	Hicks Costarino	3
23a	Santini Bros.	6
23b	Santini Bros.	2
24.		4
25.	Metromedia	2
26.	Canover Paper	2
27.	E. Greene Paper	2
28.	Leviton Mfg. Co.	4

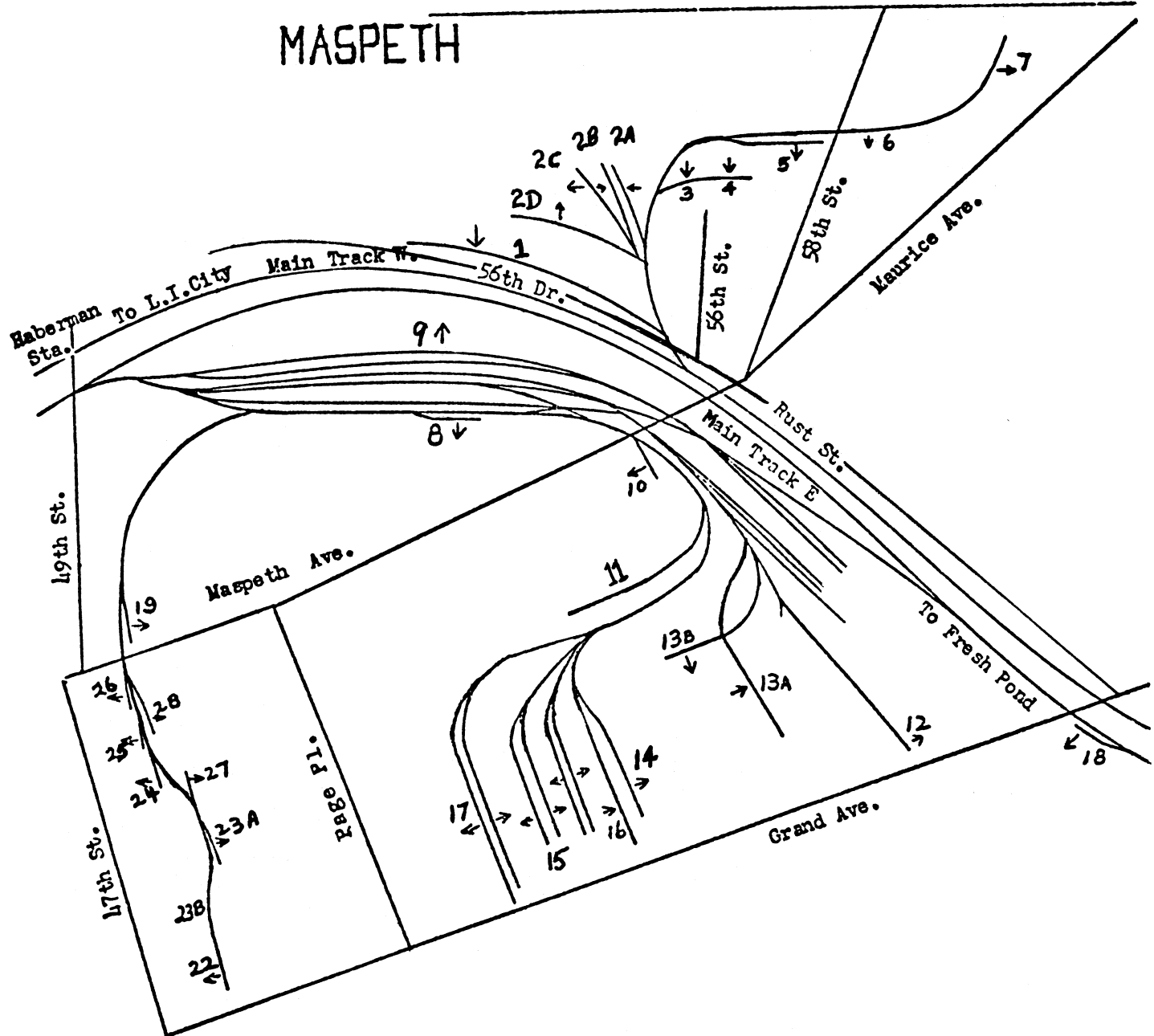

Arrows show from car to point unloaded into
 Where no arrow shown, can be unloaded from
 either side

FRESH POND

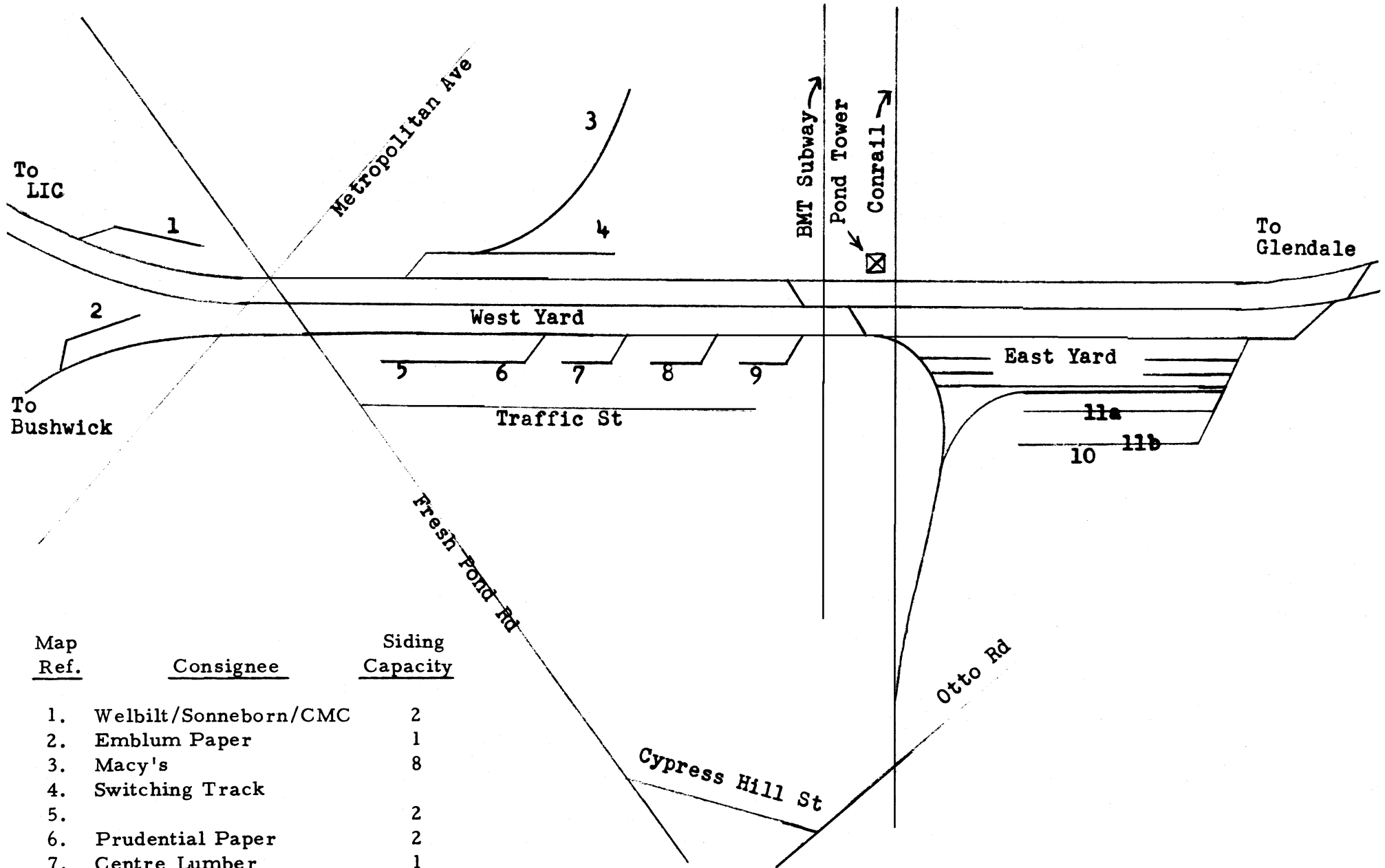

<u>Map Ref.</u>	<u>Consignee</u>	<u>Siding Capacity</u>
1.	Welbilt/Sonneborn/CMC	2
2.	Emblum Paper	1
3.	Macy's	8
4.	Switching Track	
5.		2
6.	Prudential Paper	2
7.	Centre Lumber	1
8.	J. Eisenberg & Sons	4
9.	Allegheny Tissue	4
10.	Dubovsky & Son	2
11a.	Team Tracks	
11b.	Team Tracks	

Bushwick Place

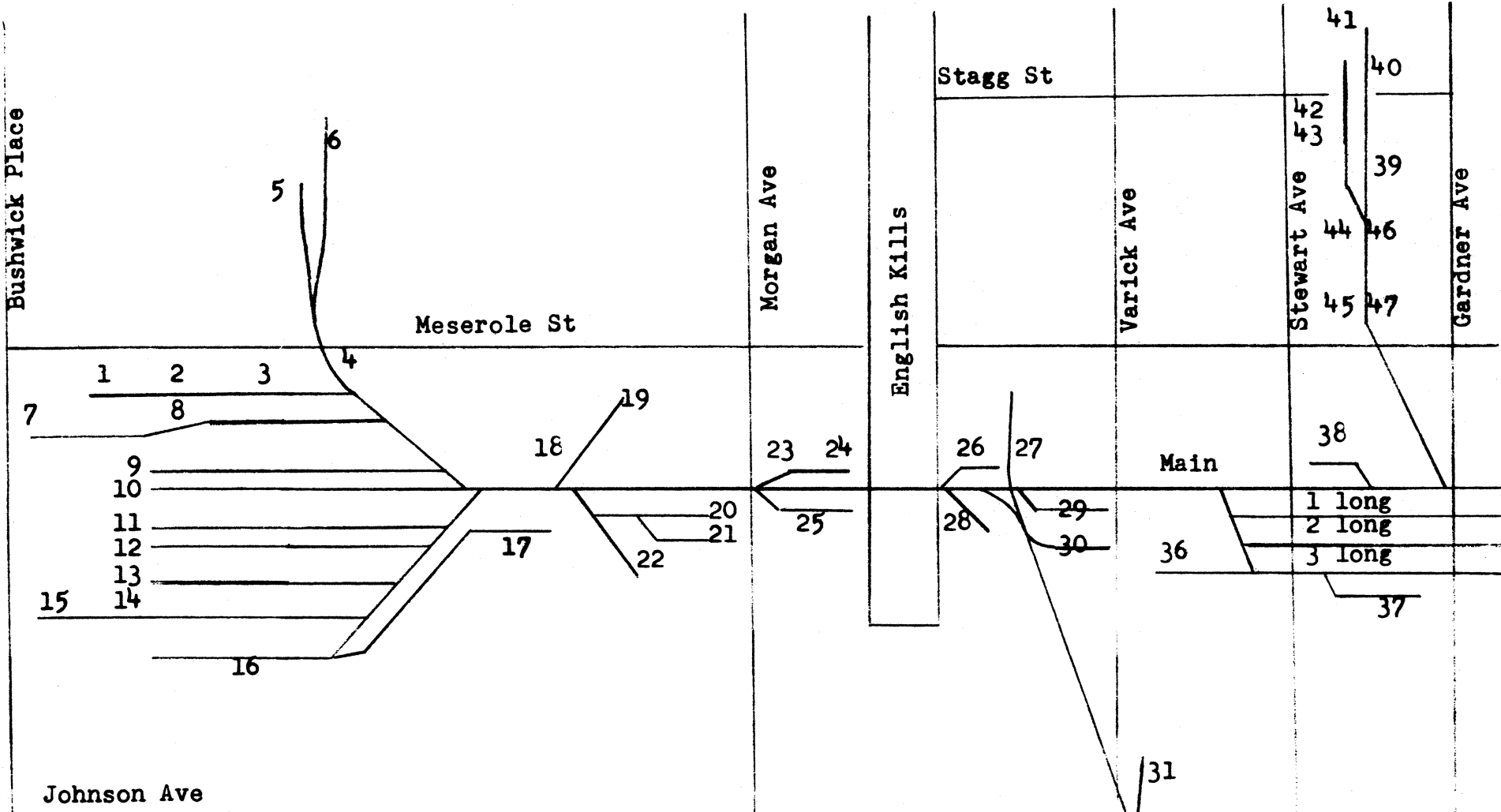

Johnson Ave

Map Ref. Consignee Siding Capacity

1.	Trio Chemical	2	17.	Webb Offset	3	33.	McKesson Chemical	3
2.	Hemley Supply	1	18.	Morton Paper	1	34.	Japan Foods	1
3.			19.	Remor Packing	1	35.		
4.	Sabin Metal	1	20.			36.	Enequist Chemical	1
5.	General Tin	1	21.			37.	Temo Sales	5
6.			22.			38.		
7.	Bushwick Town Patent (Von Damm)	4	23.	Lee Story	1	39.	Rutgers Metal	1
8.	Team Track #2		24.	Shannon Trucking & D & D Wiping Cloth	2	40.	Stagg Warehouse	2
9.	Team Track #3		25.	Envelope Convertors		41.	Elm Coated (old)	1
10.	Team Track #4		26.	Albert Pipe (old)	2	42.	Louis Farth	1
11.	Team Track #5		27.	Tubeco	4	43.	Dyber Company	1
12.	Team Track #6		28.	Albert Pipe (new)	2	44.	Dimension Lumber	1
13.	Team Track #7		29.	Icing Yard		45.	F & F Trucking & D & M Lumber	1
14.	Team Track #8		30.			46.	Hostess	1
15.	Miron Lumber		31.	U.S. Paper Bag	1	47.	Continental Combining Corp.	1
16.	Marshor Trading	3	32.	Goldberger Doll	3			

Flushing Ave.

BUSHWICK

MAP #1

10

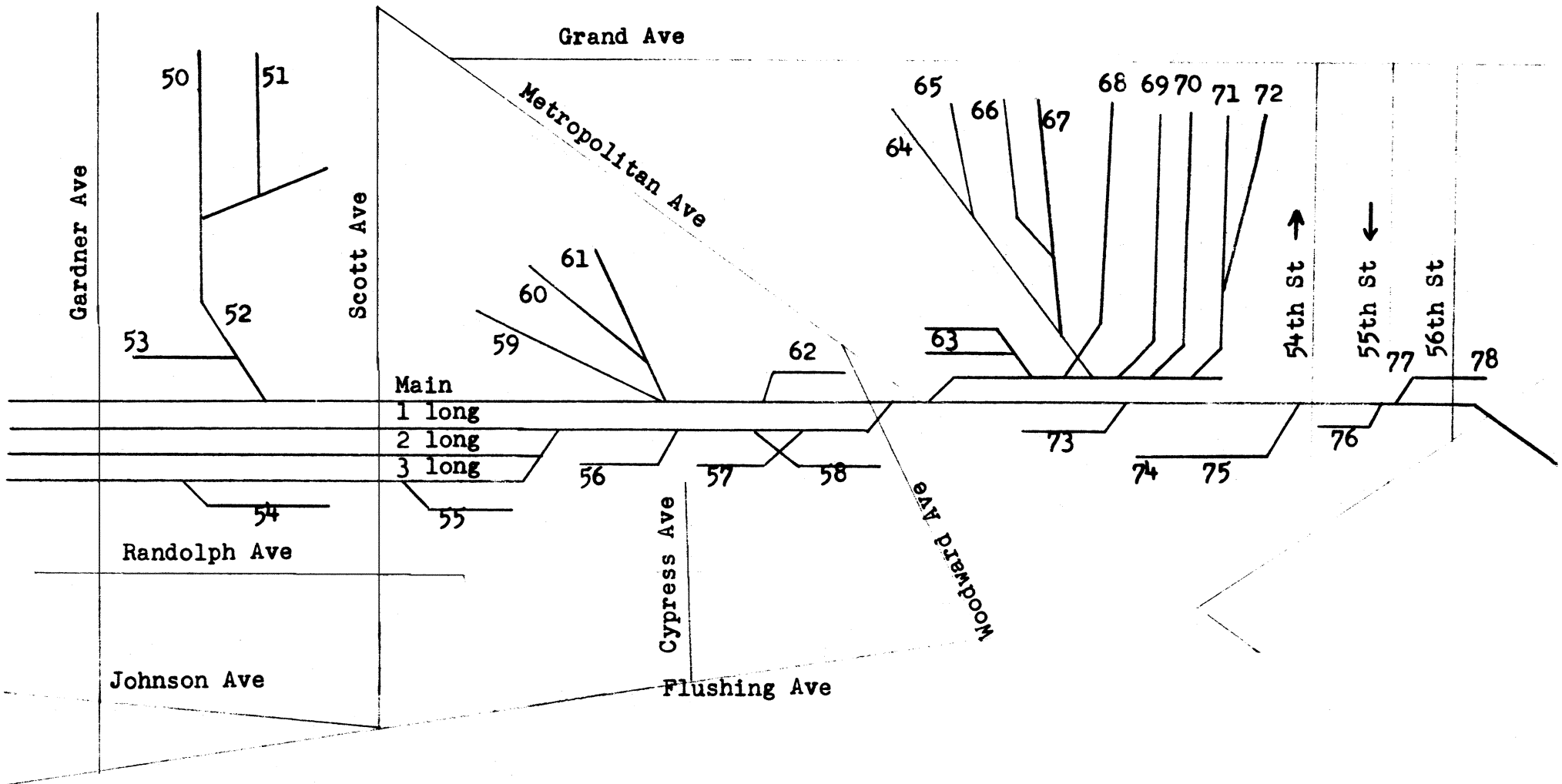

<u>Map Ref.</u>	<u>Consignee</u>	<u>Siding Capacity</u>
50.	Elm Coated (new)	1
51.	J. Rabinowitz	4
52.	Monarch Lumber	3
53.	Republic Paper	2
54.	Consolidated Charcoal	6
55.	Robinson Chemical	1
56.	Brooklyn Steel Whs.	3
57.		
58.	Joseph Aronauer	1
59.	Republic Steel #1	1
60.	Republic Steel #2	1
61.	Republic Steel #3	1
62.	Feldman Lumber	2
63.		
64.		
65.		
66.		
67.	Canover Paper	
68.		
69.	Arch Bilt Container	3
70.	National Can	4
71.	Strauss Stores	2
72.		
73.		
74.	Brenzac Fiber	1
75.	Atlas Corrugated	2
76.	Manhattan Door	2
77.	F & M Trading & Richter & Ratner	1

GLENDALE

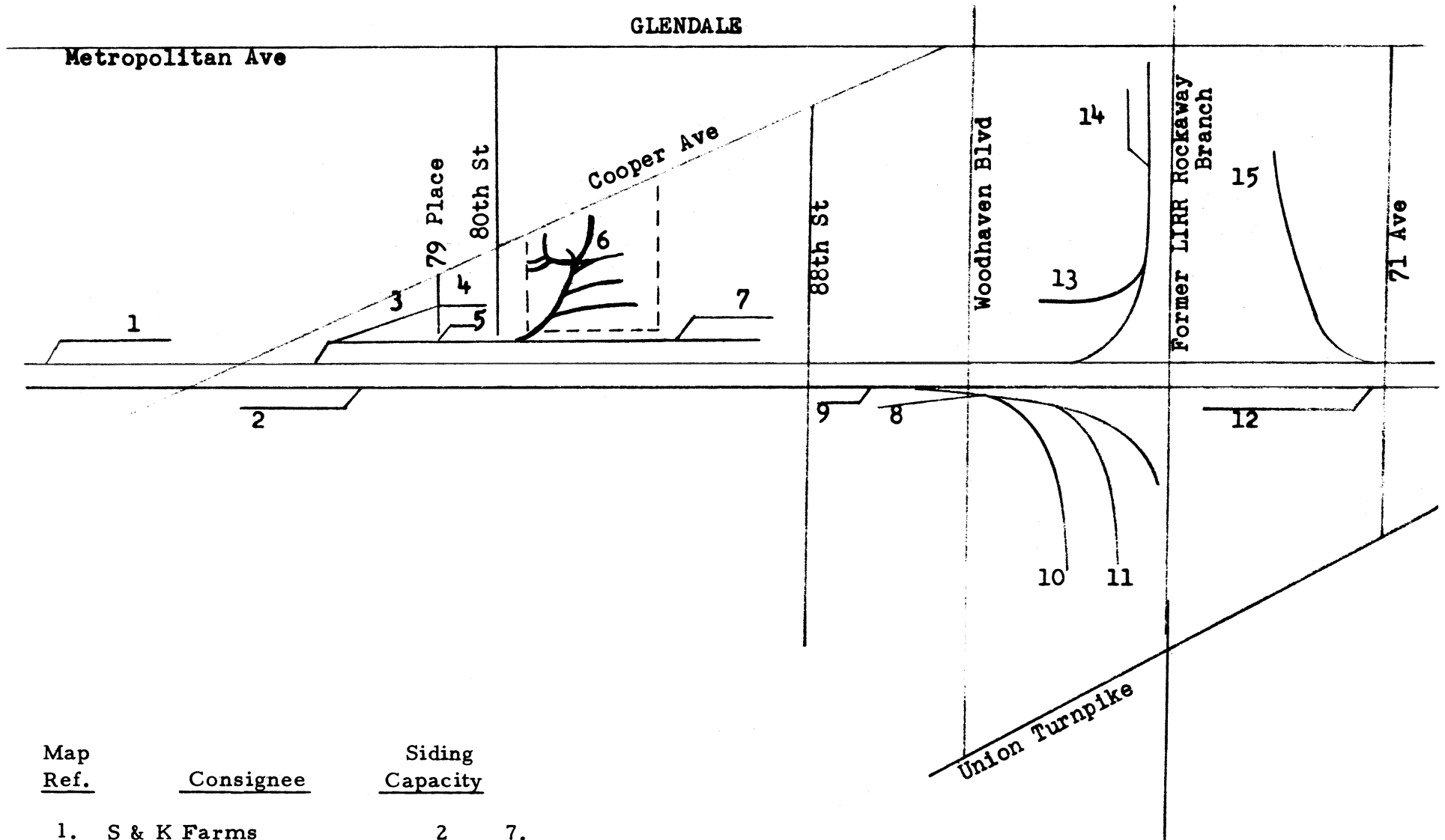

<u>Map Ref.</u>	<u>Consignee</u>	<u>Siding Capacity</u>
1.	S & K Farms	2
2.	Kliegman Bros. / Jordan Chemical	2
3.	Independent Chemical	2
4.	Timms Trucking	1
5.	Anco Wood	1
6.	Atlas Terminal Complex: Merchant Supply Federal Warehouse Brainum Shanker	7.
8.	GE Export/Purex	2
9.	White Pine Sash	3
10.		3
11.	Wolf's Head Oil	3
12.	Better Brands	10
13.	GE Lamp Div.	4
14.	General Fibre	3
15.	Modern Maid	3

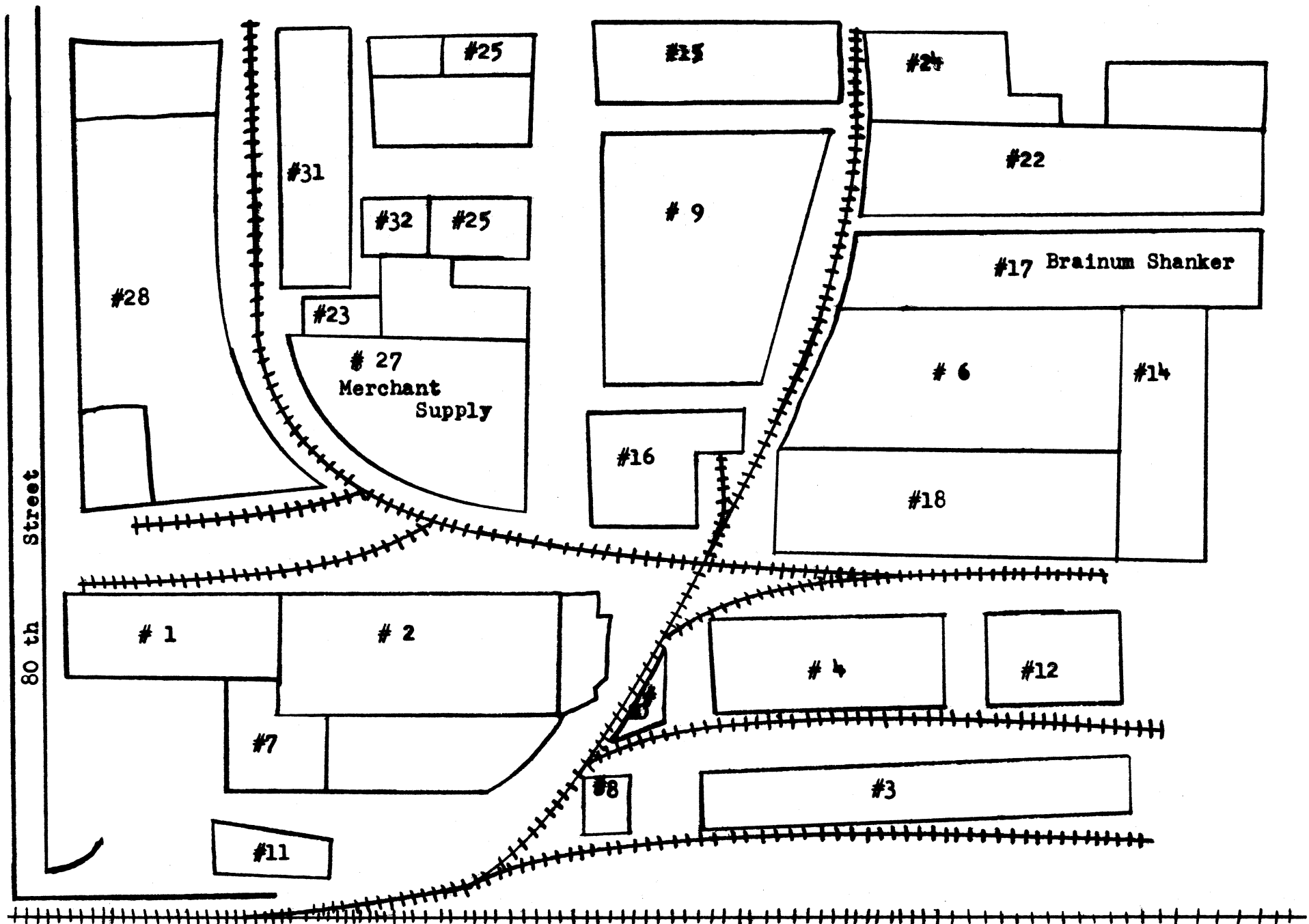

ATLAS TERMINAL (GLENDALE)

* NOTE * - Cars Placed On Lead To Terminal And Switched By Atlas Engine

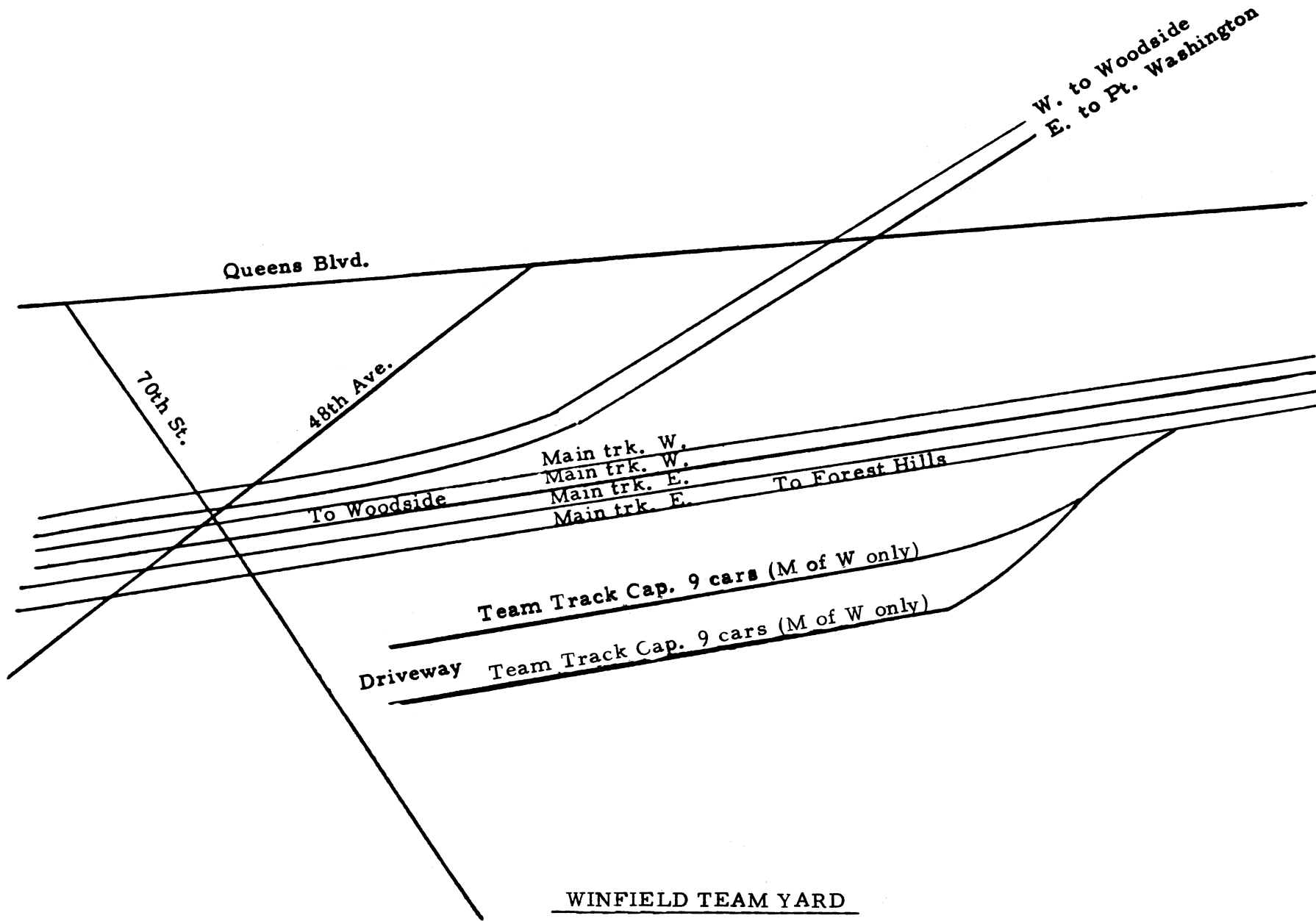

WINFIELD TEAM YARD

Map Ref.	Consignee	Siding Capacity
----------	-----------	-----------------

- | | | |
|----|-------------------|----|
| 1. | Fodera | 5 |
| 2. | Bono Sawdust | 2 |
| 3. | J J T Trucking | |
| 4. | Team Tracks | 11 |
| 5. | American Bakeries | 6 |
| 6. | Niemand Bros. | 3 |

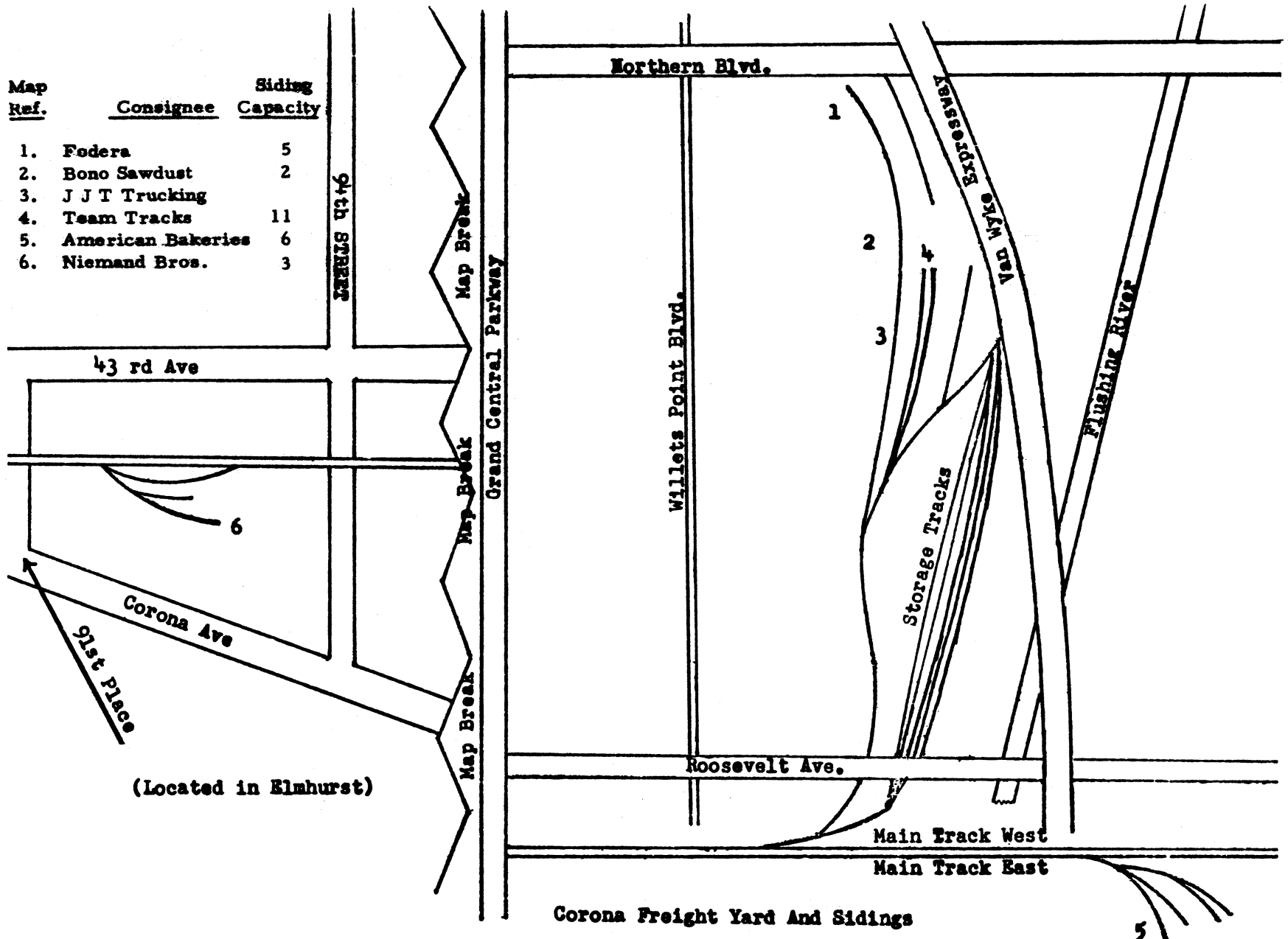

(Located in Elmhurst)

Corona Freight Yard And Sidings

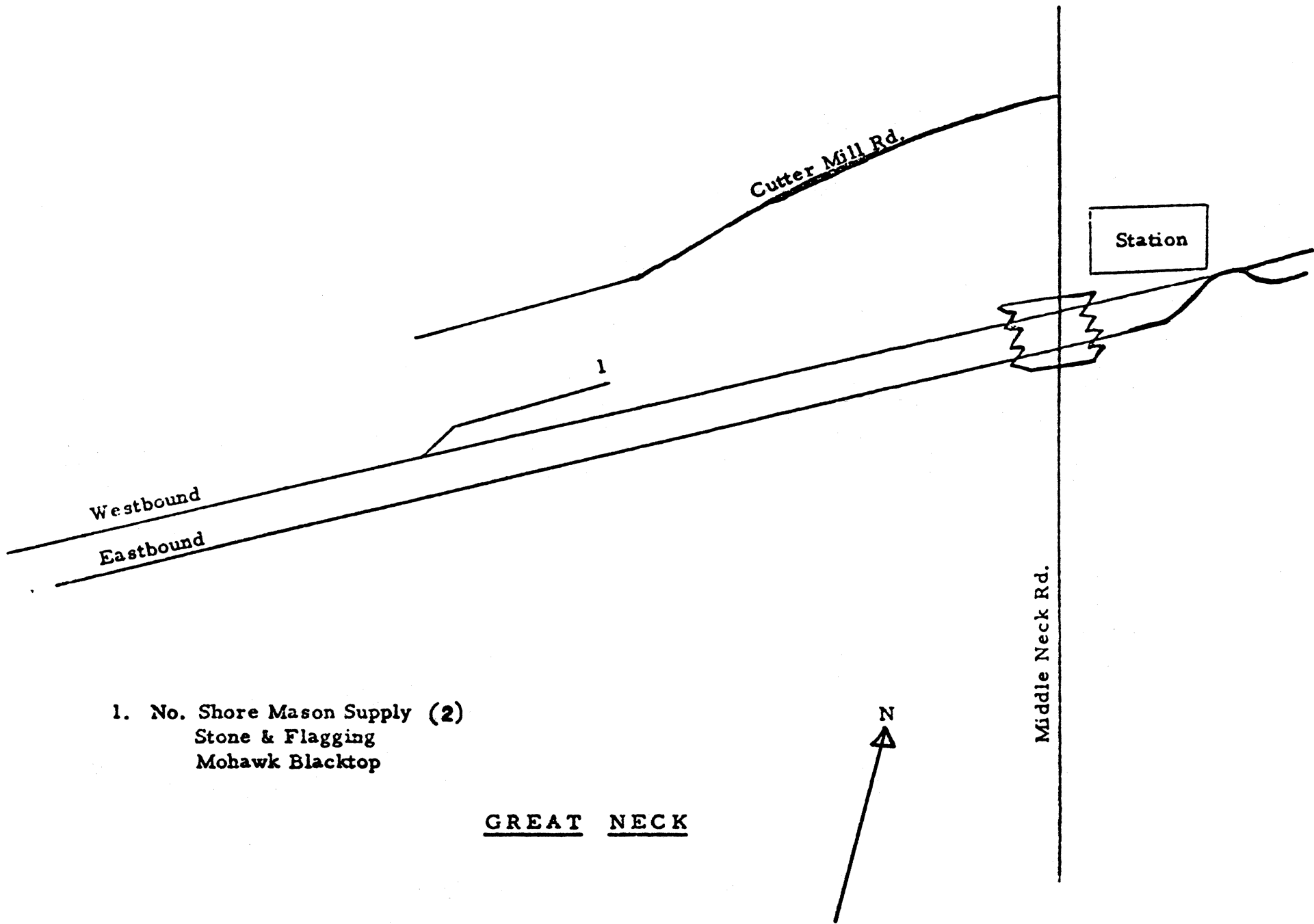

- 1. No. Shore Mason Supply (2)
Stone & Flagging
Mohawk Blacktop

JAMAICA MAP #1

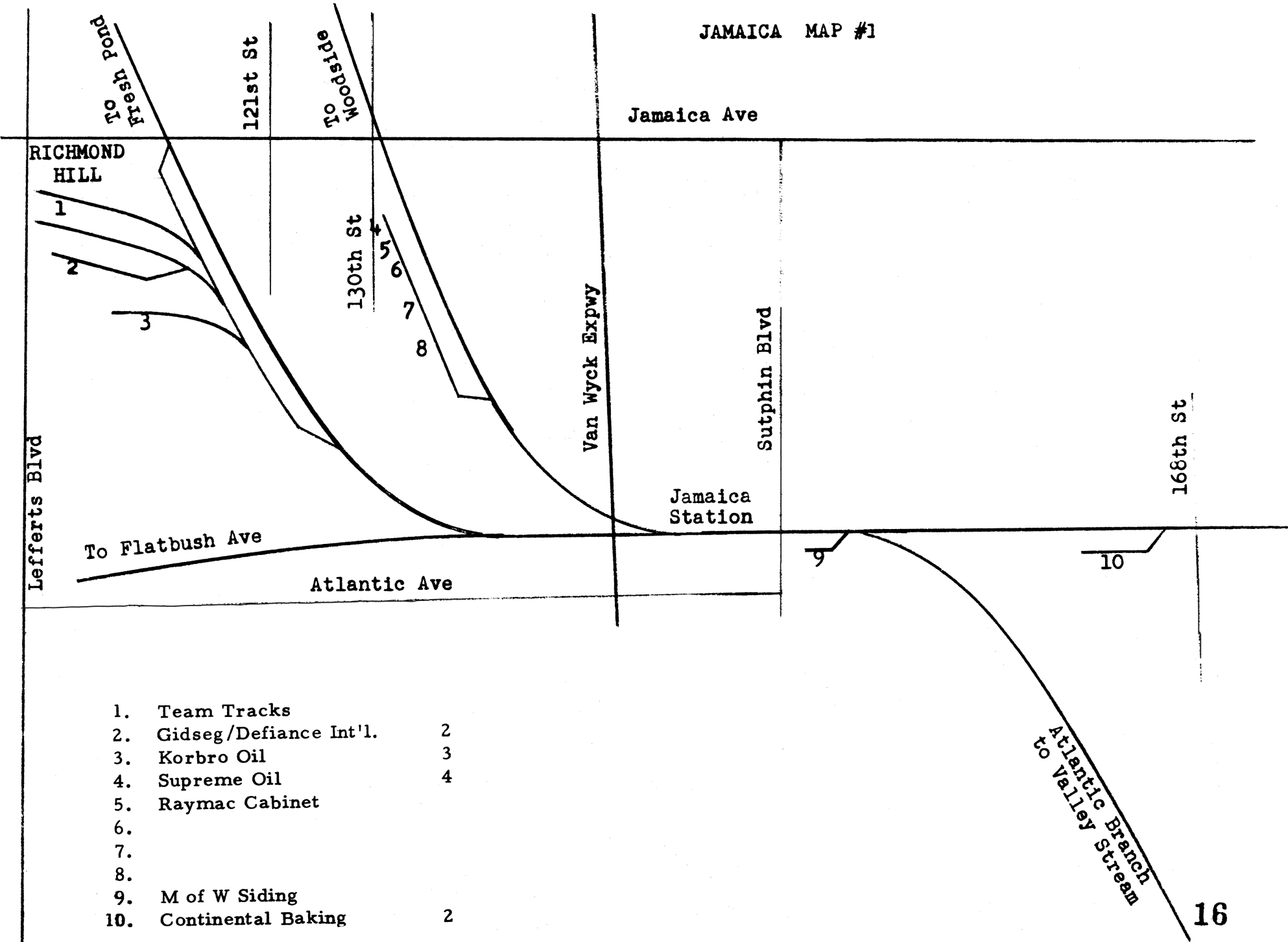

RICHMOND HILL

1

2

3

130th St

4

5

6

7

8

Van Wyck Expwy

Sutphin Blvd

Jamaica Station

168th St

To Flatbush Ave

Atlantic Ave

9

10

Atlantic Branch
to Valley Stream

- 1. Team Tracks
- 2. Gidseg/Defiance Int'l. 2
- 3. Korbro Oil 3
- 4. Supreme Oil 4
- 5. Raymac Cabinet
- 6.
- 7.
- 8.
- 9. M of W Siding
- 10. Continental Baking 2

Jamaica Ave

To
Jamaica Sta.

To Queens
Village

183 St

26

27

28

29

Holban Yard (Hillside)
Westbound Classification Yard

178th St

30

31

32

33

34

Liberty Ave

Hollis Ave

44

46

35

36

45

48

49

52

53

50

51

Holban Yard
Eastbound Yard

54

55

56

57

58

Dunkirk St

Farmers Blvd

JAMAICA MAP#2

Map Ref.	Consignee	Siding Capacity
26.	J & L Adikes	2
27.	Ideal Toy	3
28.	Jamaica Lumber (Spiked)	2
29.	Allied Tackless/ Industrial Plywood	1
30.	B & P Stone	1
31.	Marfin Redi Mix	4
32.	Jamaica Paper Stock	6
33.		
34.	Gertz Warehouse	6
35.		3
36.	Dairy Cap	2
37.	Jamaica Water Supply	6
38.	West Side Corporation	7
39.	Honeywell Farms	
40.	Shea Trucking	2
41.		
42.	Giove Company	4
43.	Associated Foods	6
44.	Hinsch Produce	2
45.	Giove Company	2
46.		
47.	Track Removed	
48.	Martin Paint	8
49.	Freight House Track	
50.	Cripple Track	
51.	Top (Team) Track	8
52.	Smith Chemical	3
53.	Neptune Paper	1
54.		3
55.	W H Foods	1
56.	Sun Dew Corporation	4
57.	Modern Maid	1
58.	Modern Maid	6
59.	M of W Yard	12

Montauk Branch

To Valley Stream

174th St

110th Ave

59

VALLEY STREAM

<u>Map Ref.</u>	<u>Consignee</u>	<u>Siding Capacity</u>
1.	Team Track #1	9
2.	Team Track #2	6
3.	Barton	18
4.	Baisley Lumber	4

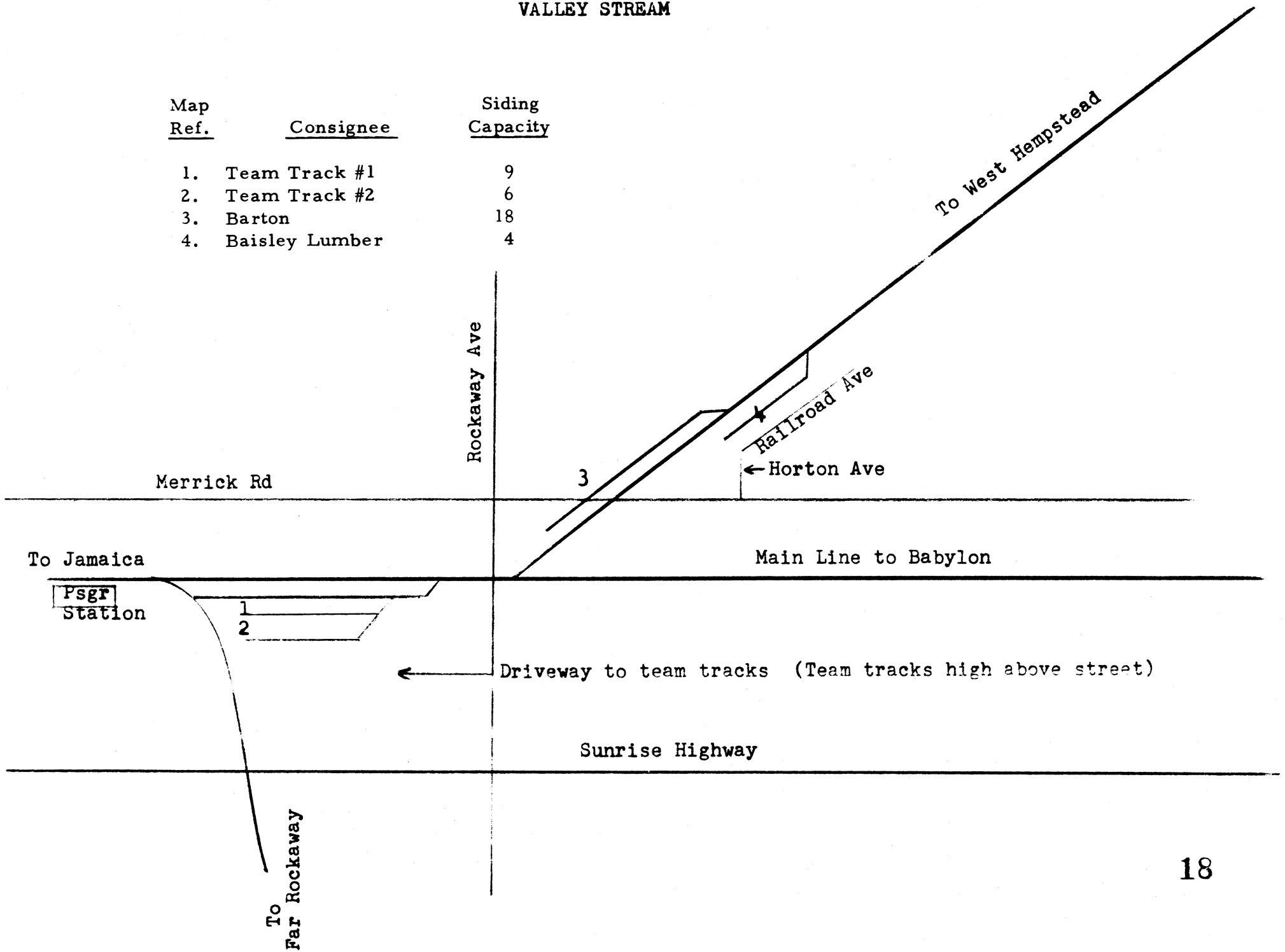

MALVERNE

WEST HEMPSTEAD

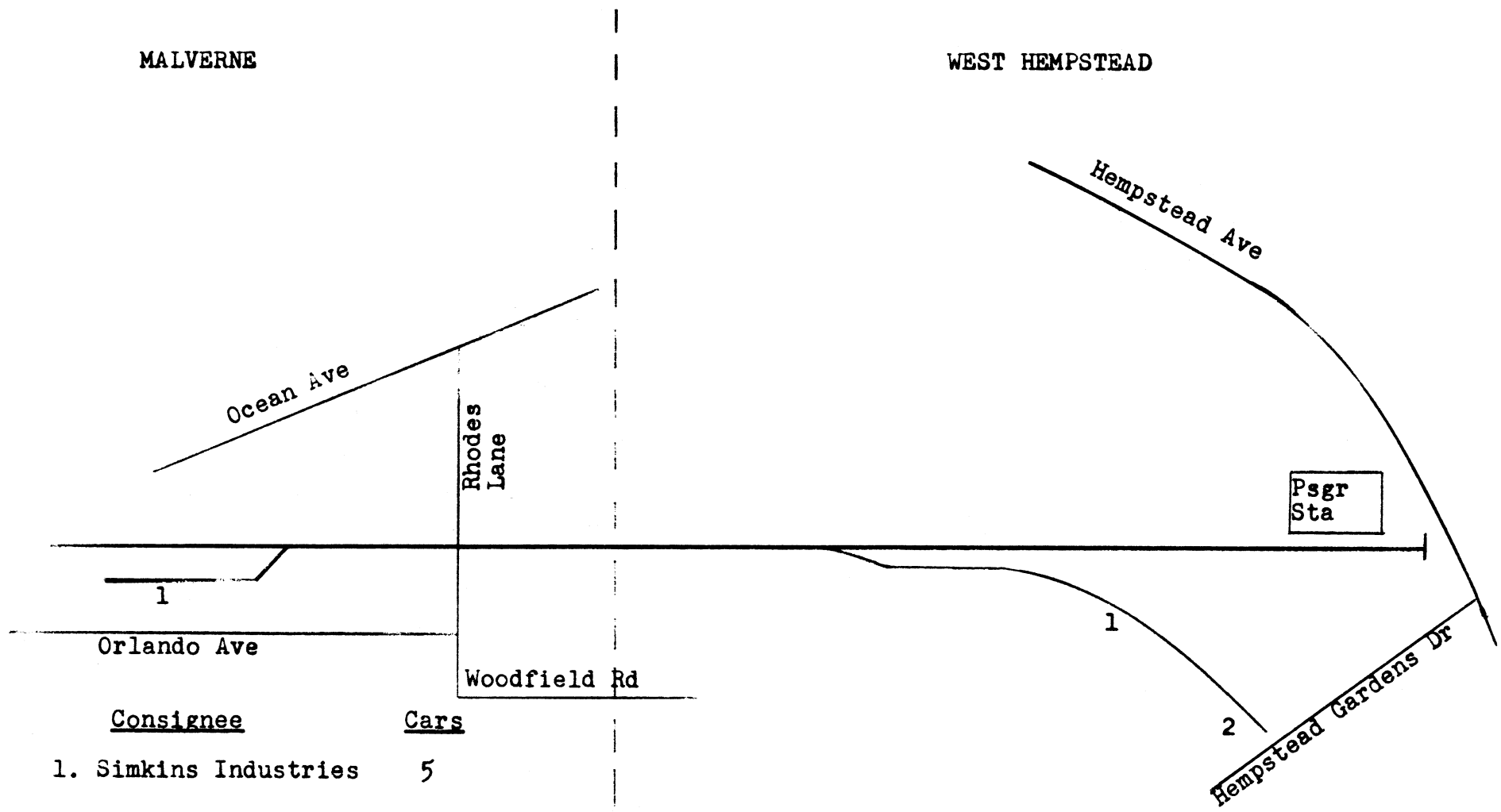

<u>Consignee</u>	<u>Cars</u>
1. Simkins Industries	5

1. L.I. Wholesalers	4
2. InterCounty Bakers	2

ISLAND PARK
LILCO FACILITY

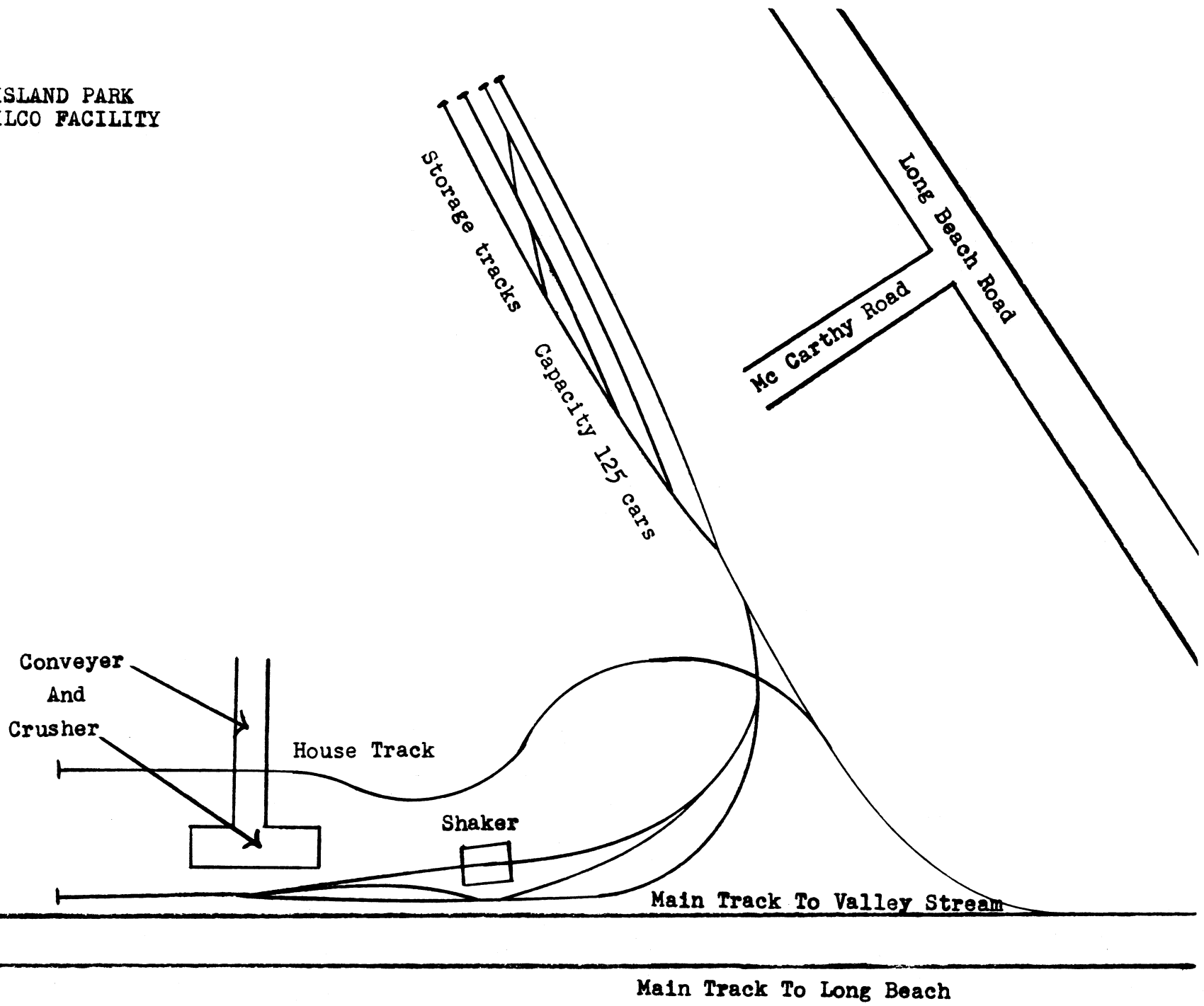

(Official Name Of Station Is Long Beach)

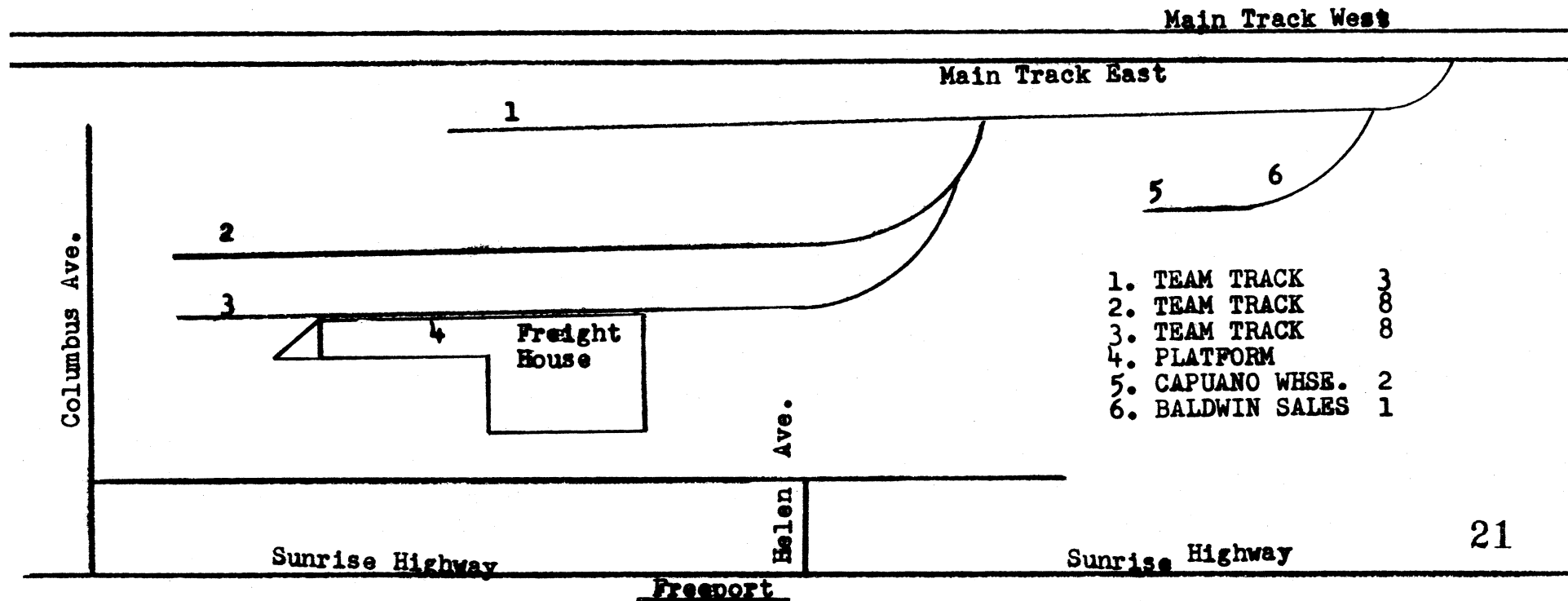
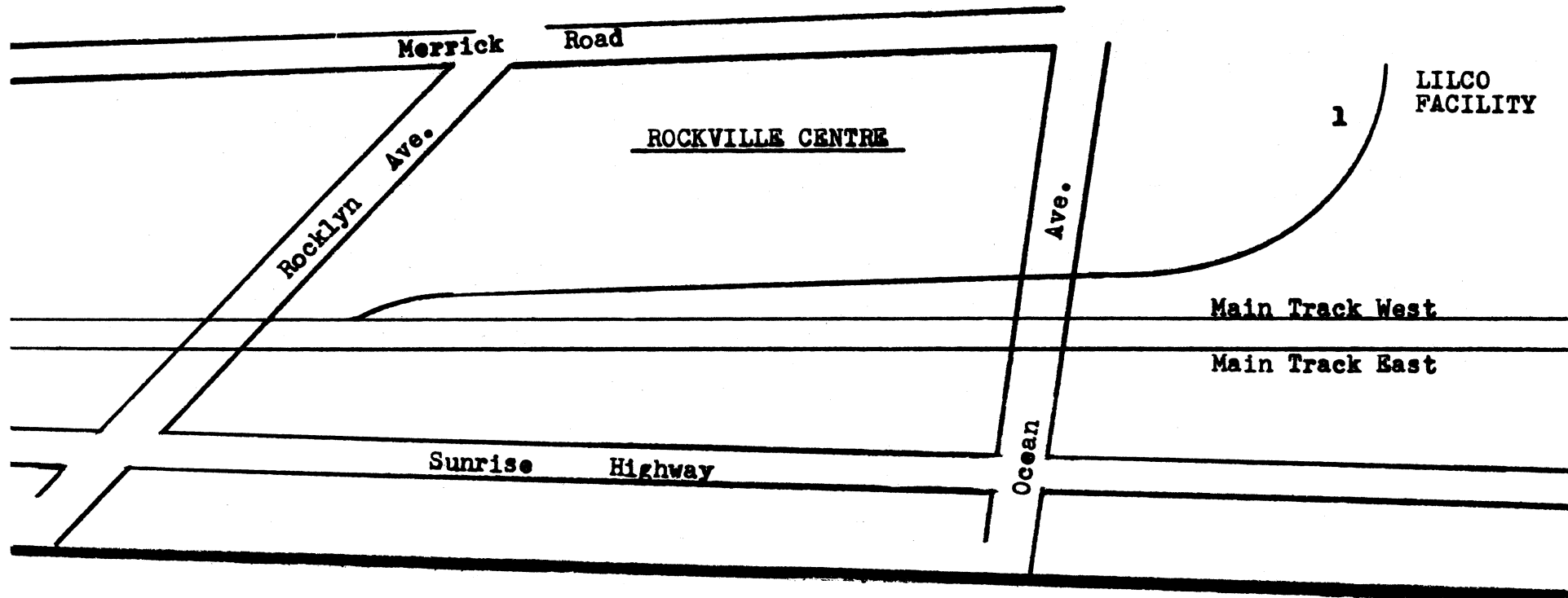

- | | | |
|----|---------------|---|
| 1. | TEAM TRACK | 3 |
| 2. | TEAM TRACK | 8 |
| 3. | TEAM TRACK | 8 |
| 4. | PLATFORM | |
| 5. | CAPUANO WHSE. | 2 |
| 6. | BALDWIN SALES | 1 |

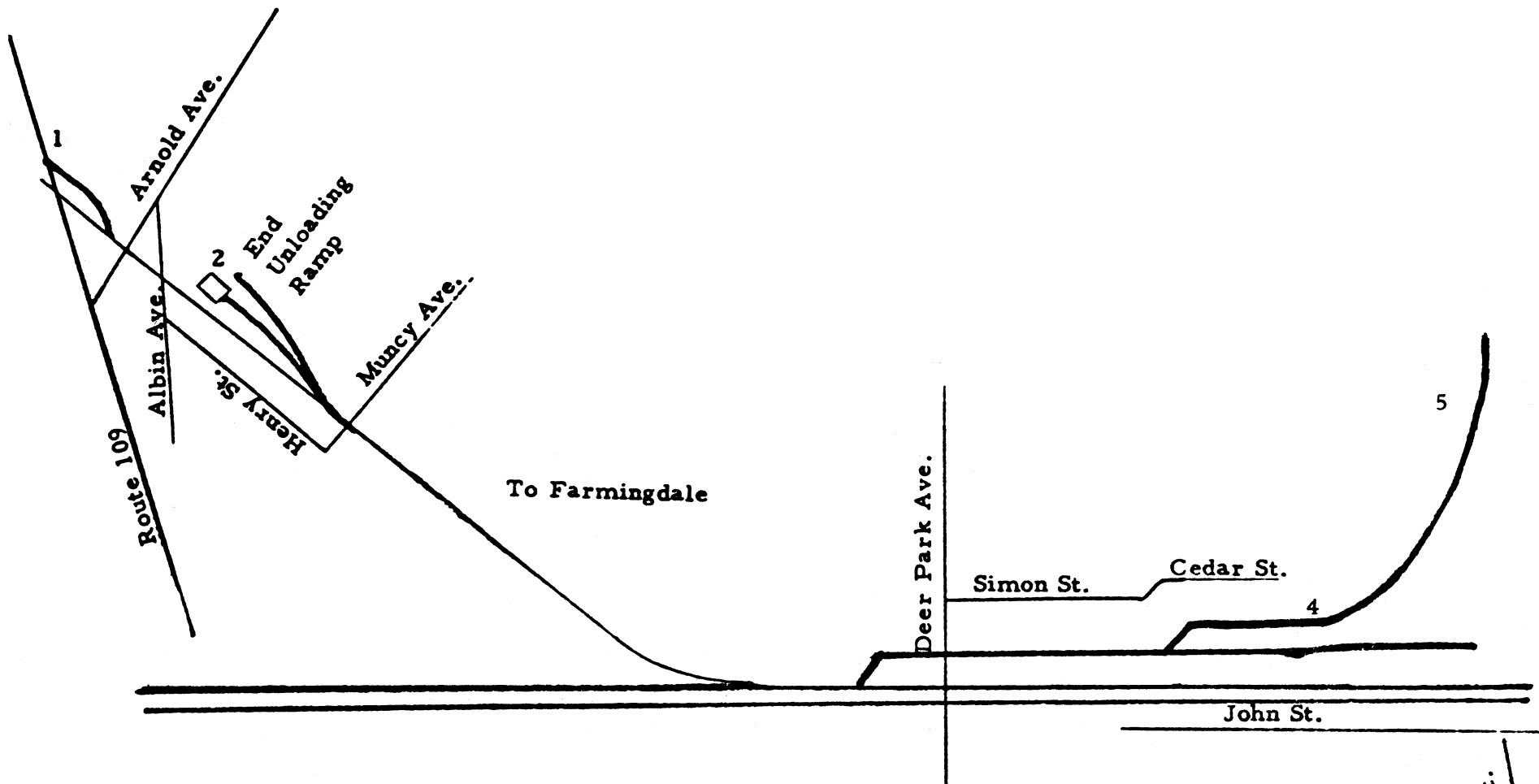

- | | |
|--|--------|
| 1. Saston Bldg. Material-Flushing Supply East | 2 |
| 2. Team Yard | 3 EACH |
| 4. General Builders (Risberg Mill) Sherwood Lbr. Co. | 3 |
| 5. Palm Trucking | 15 |

BABYLON

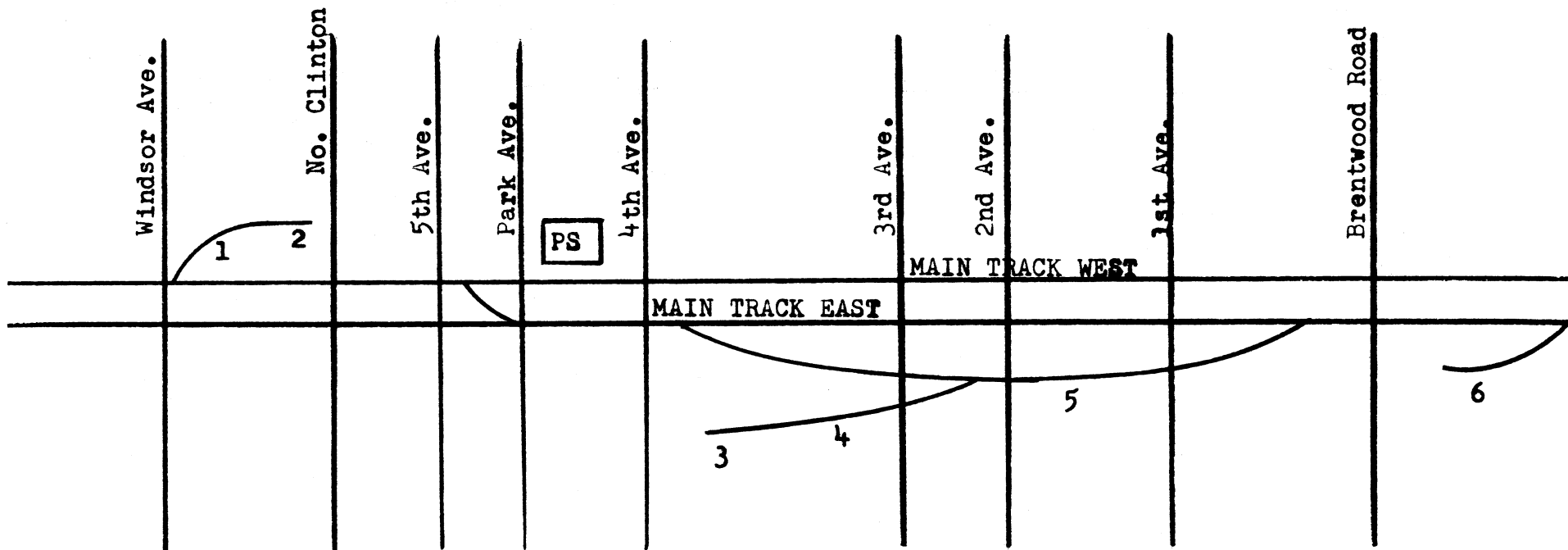

BAY SHORE

<u>Map Ref.</u>	<u>Consignee</u>	<u>Siding Capacity</u>
1.	Bay Shore Flooring	5)
2.	Voges Feed	5) Same Track
3.	G.H.K. / Manson Barish	2
4.	Team Track	5
5.	Passing Track	25
6.	Selchow & Righter	2

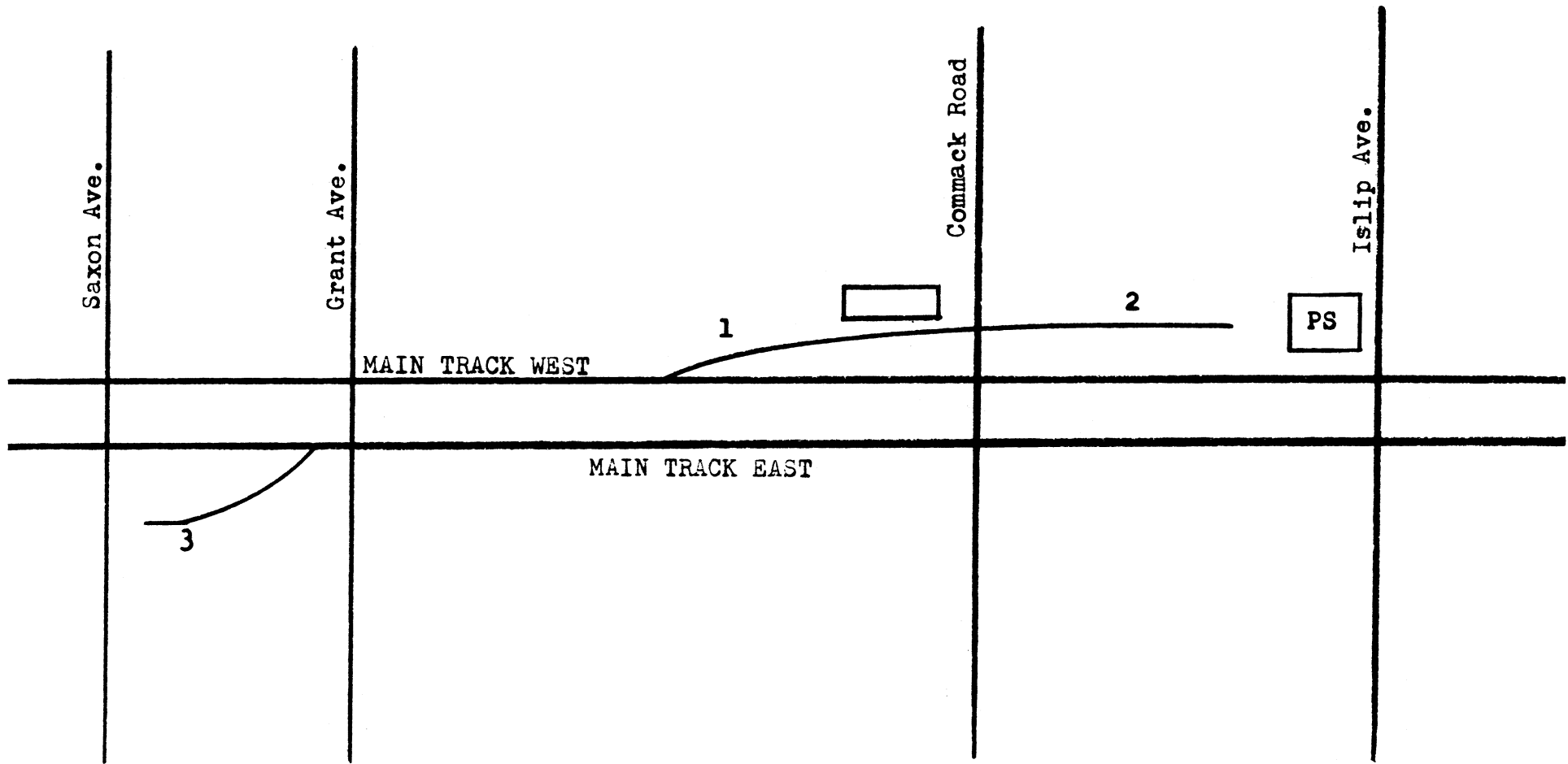

ISLIP

<u>Map Ref.</u>	<u>Consignee</u>	<u>Siding Capacity</u>
1.	84 Lumber Company	5
2.	Team Track	3
3.	Fiore Construction Co.	5

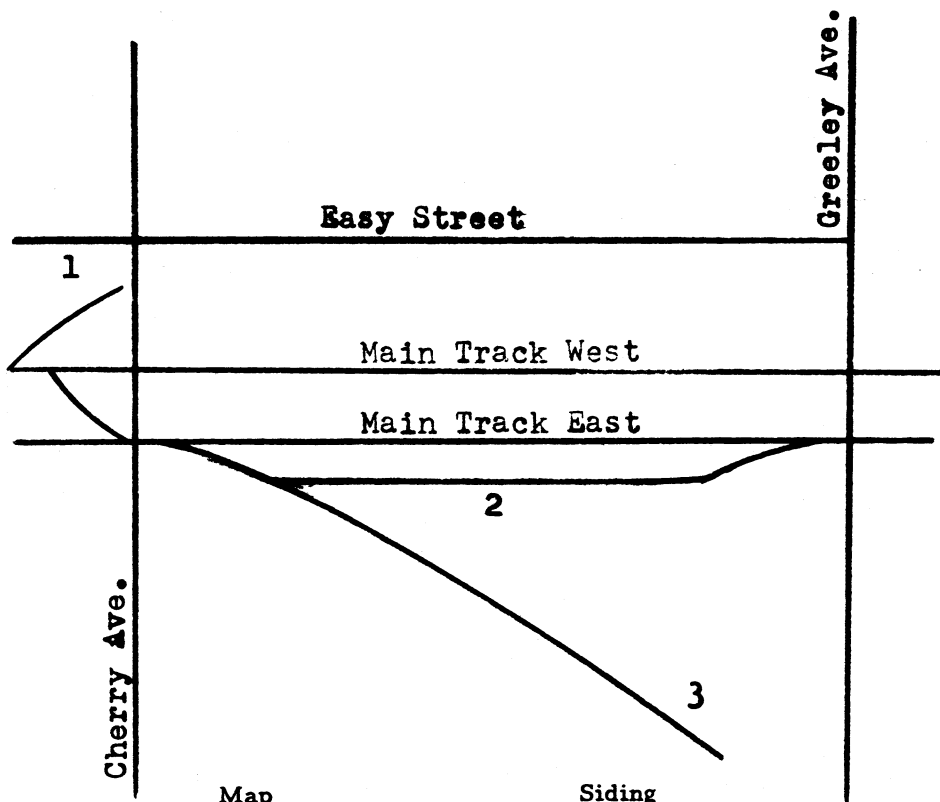

Map Ref.	Consignee	Siding Capacity
1.	Pagels / Sunshine / Cedar Beverage	3
2.	Passing Siding	3
3.	Team Track	20

SAYVILLE

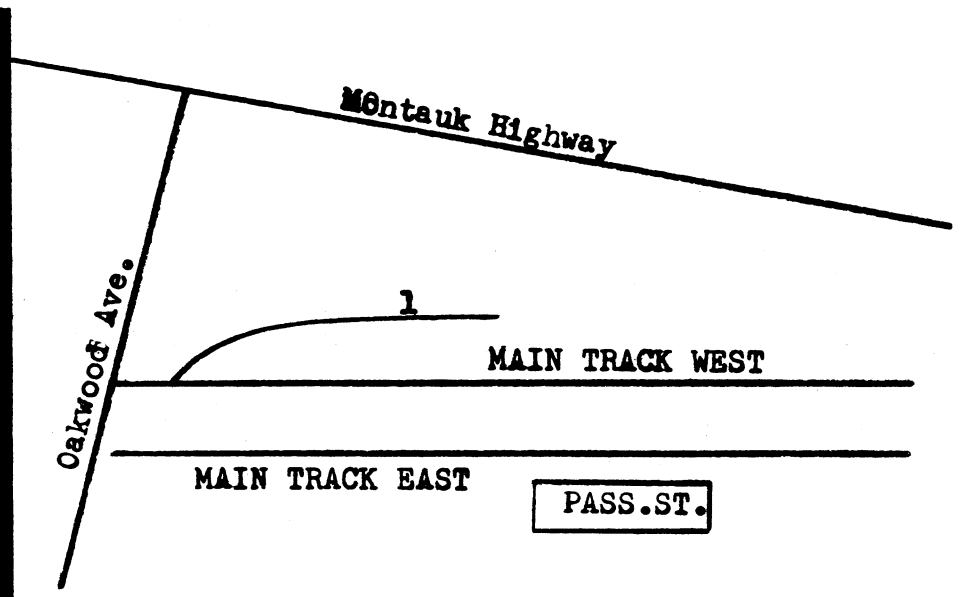

Map Ref.	Consignee	Siding Capacity
1.	Bayport Lumber	8

BAYPORT

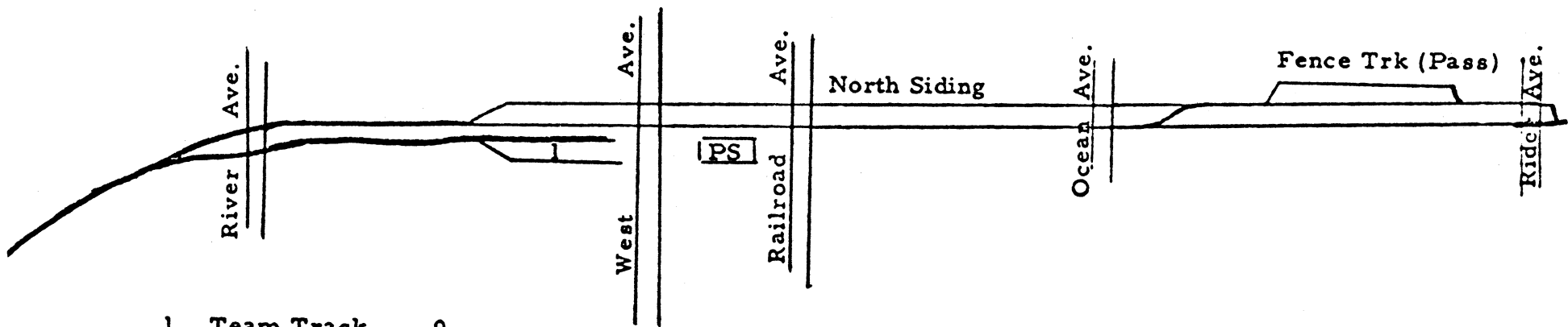

1. Team Track 9

PATCHOGUE

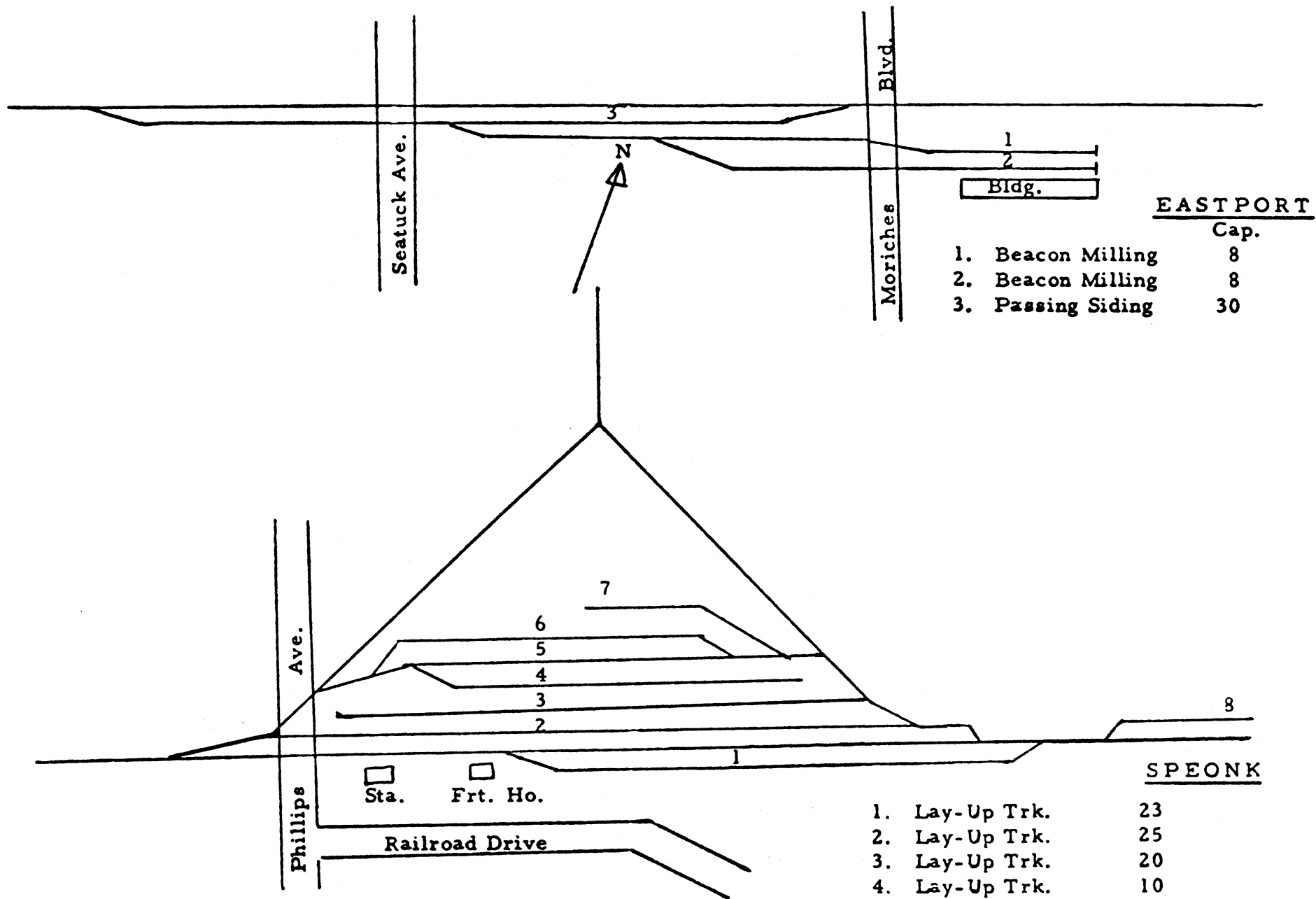

<u>EASTPORT</u>	
	Cap.
1. Beacon Milling	8
2. Beacon Milling	8
3. Passing Siding	30

<u>SPEONK</u>	
1. Lay-Up Trk.	23
2. Lay-Up Trk.	25
3. Lay-Up Trk.	20
4. Lay-Up Trk.	10
5. Lay-Up Trk.	10
6. Lay-Up Trk.	10
7. Team Trk. (3)	11
8.	12

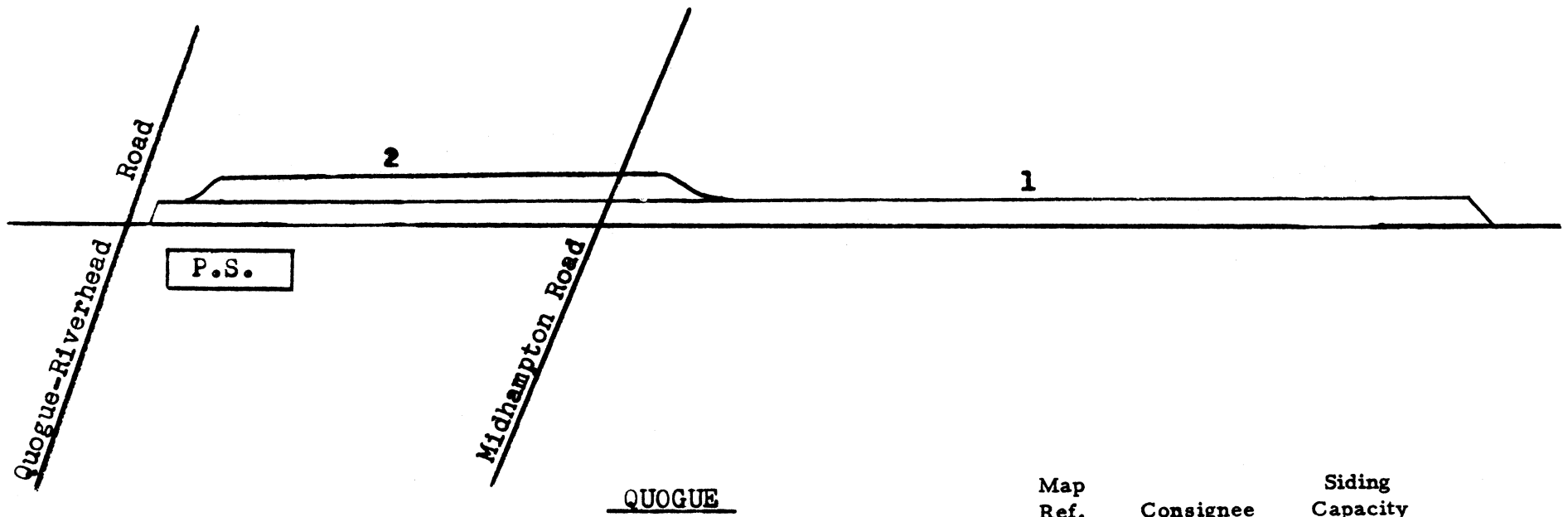

QUOGUE

<u>Map Ref.</u>	<u>Consignee</u>	<u>Siding Capacity</u>
-----------------	------------------	------------------------

1. M of W Siding

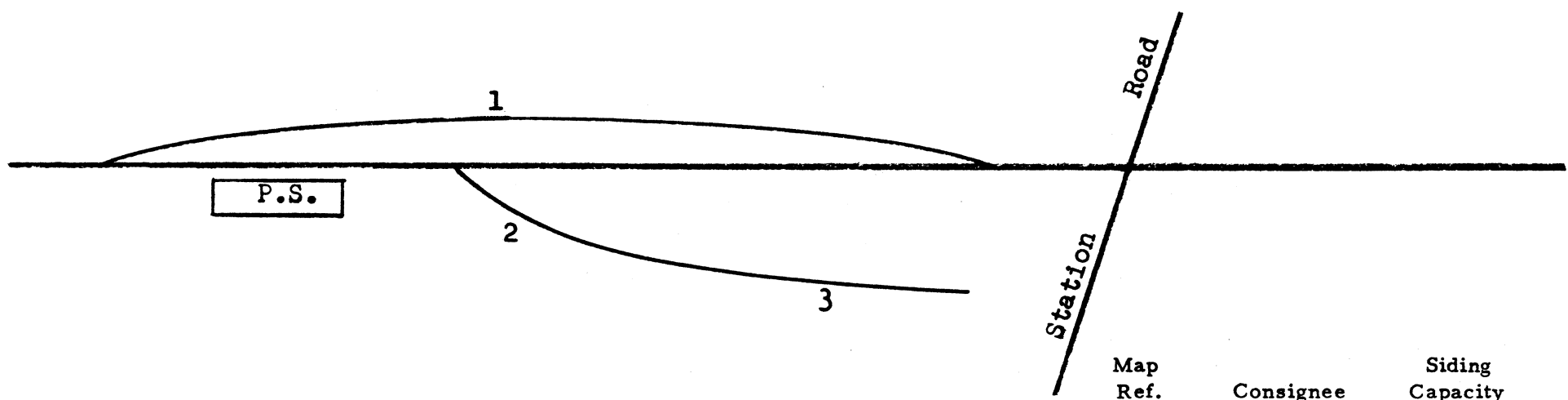

WESTHAMPTON

<u>Map Ref.</u>	<u>Consignee</u>	<u>Siding Capacity</u>
-----------------	------------------	------------------------

1. Passing Track 32
 2. Team Track 2
 3. Rogers 5

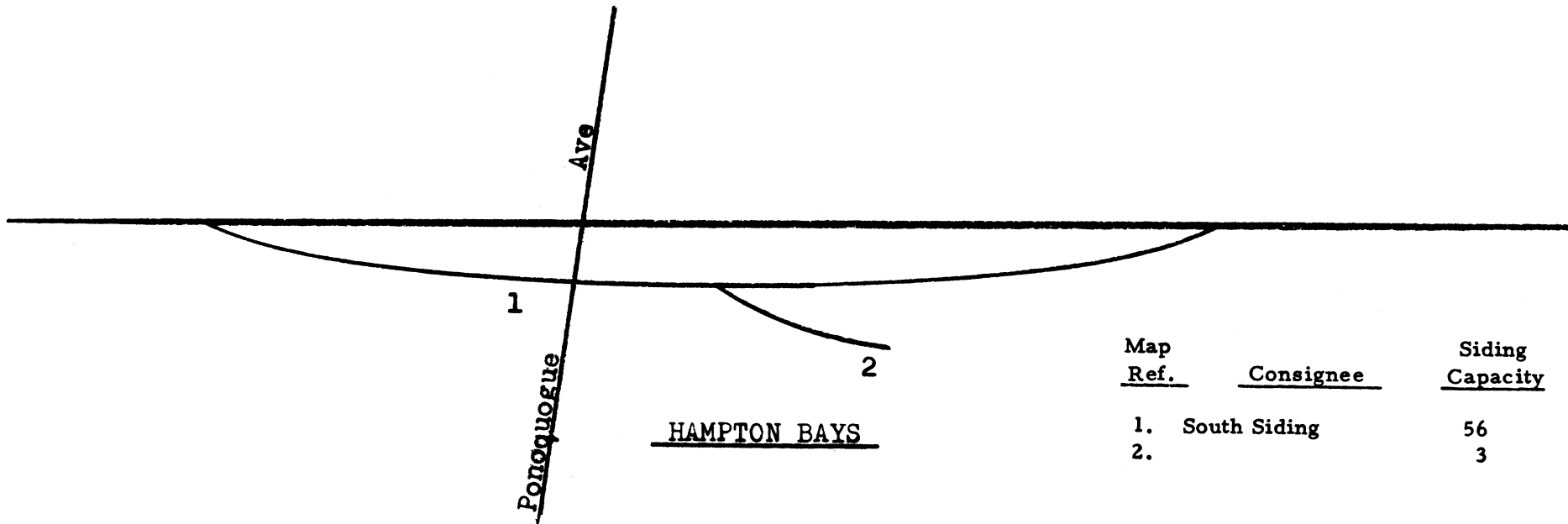

<u>Map Ref.</u>	<u>Consignee</u>	<u>Siding Capacity</u>
1.	South Siding	56
2.		3

<u>Map Ref.</u>	<u>Consignee</u>	<u>Siding Capacity</u>
1.	Team Track	8
2.	Southampton Coal	2
3.	Southampton Coal	2
4.	North Siding	43
5.	Southampton Lumber	5

SOUTHAMPTON

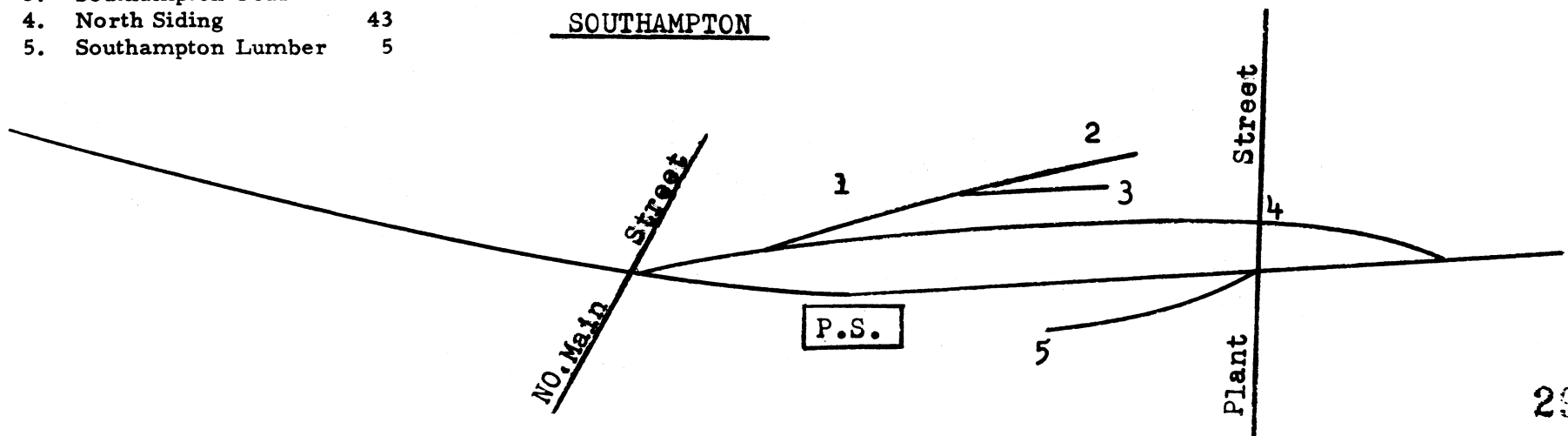

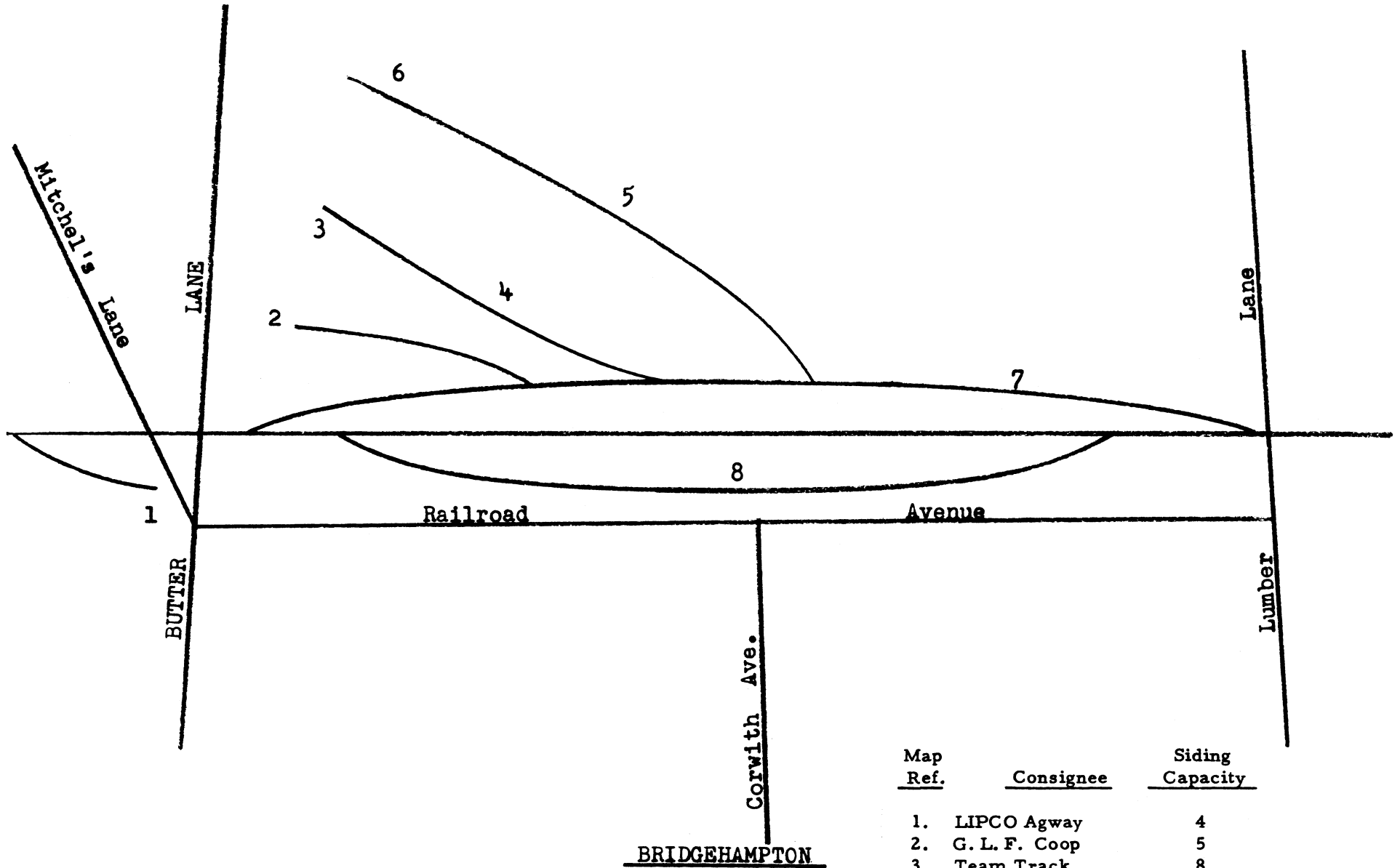

<u>Map Ref.</u>	<u>Consignee</u>	<u>Siding Capacity</u>
1.	LIPCO Agway	4
2.	G. L. F. Coop	5
3.	Team Track	8
4.	Team Track	
5.	Pulver Gas	2
6.	R. Wesnofski	6
7.	North Siding	40
8.	Passing Siding	22

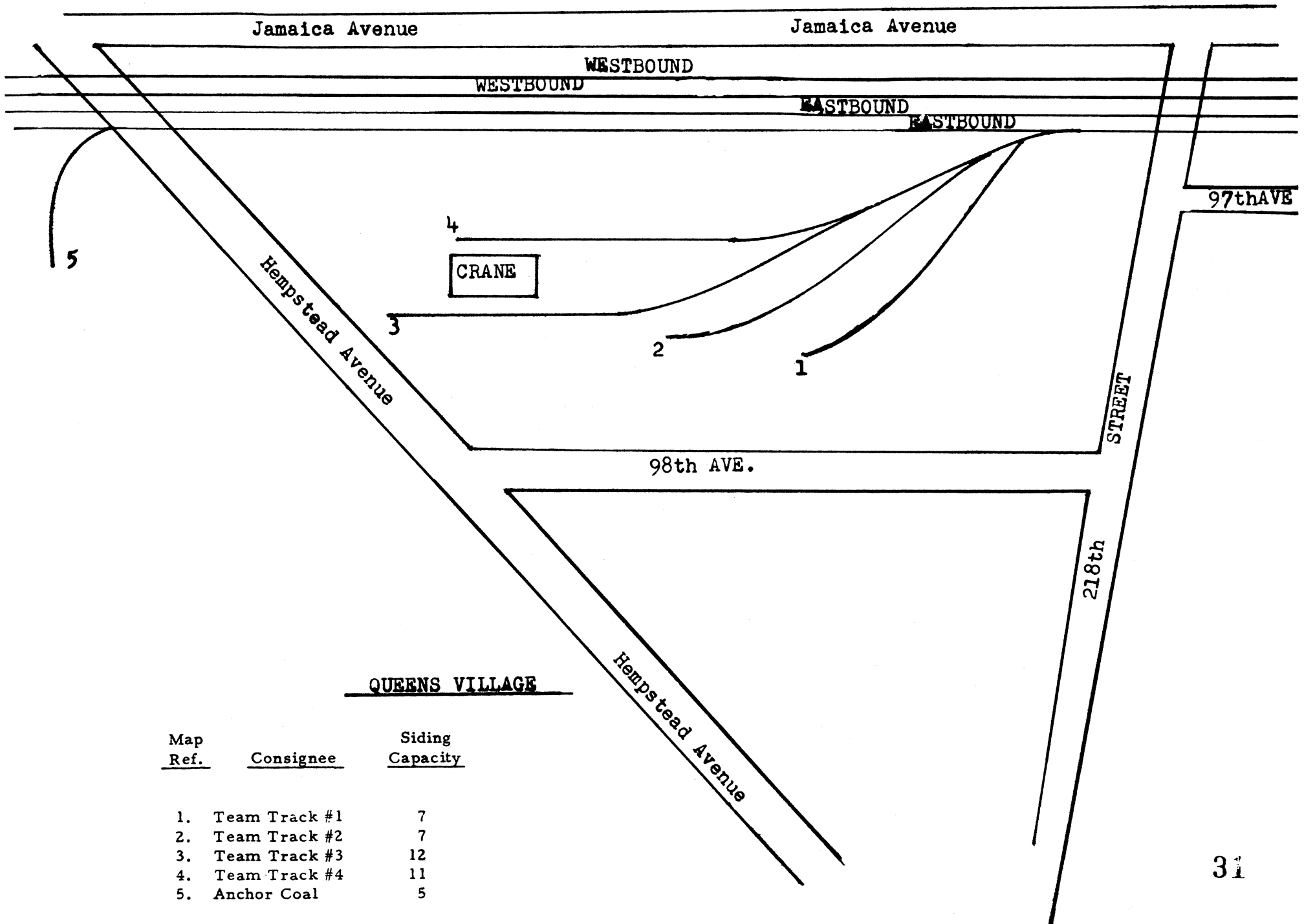

<u>Map Ref.</u>	<u>Consignee</u>	<u>Siding Capacity</u>
1.	Team Track #1	7
2.	Team Track #2	7
3.	Team Track #3	12
4.	Team Track #4	11
5.	Anchor Coal	5

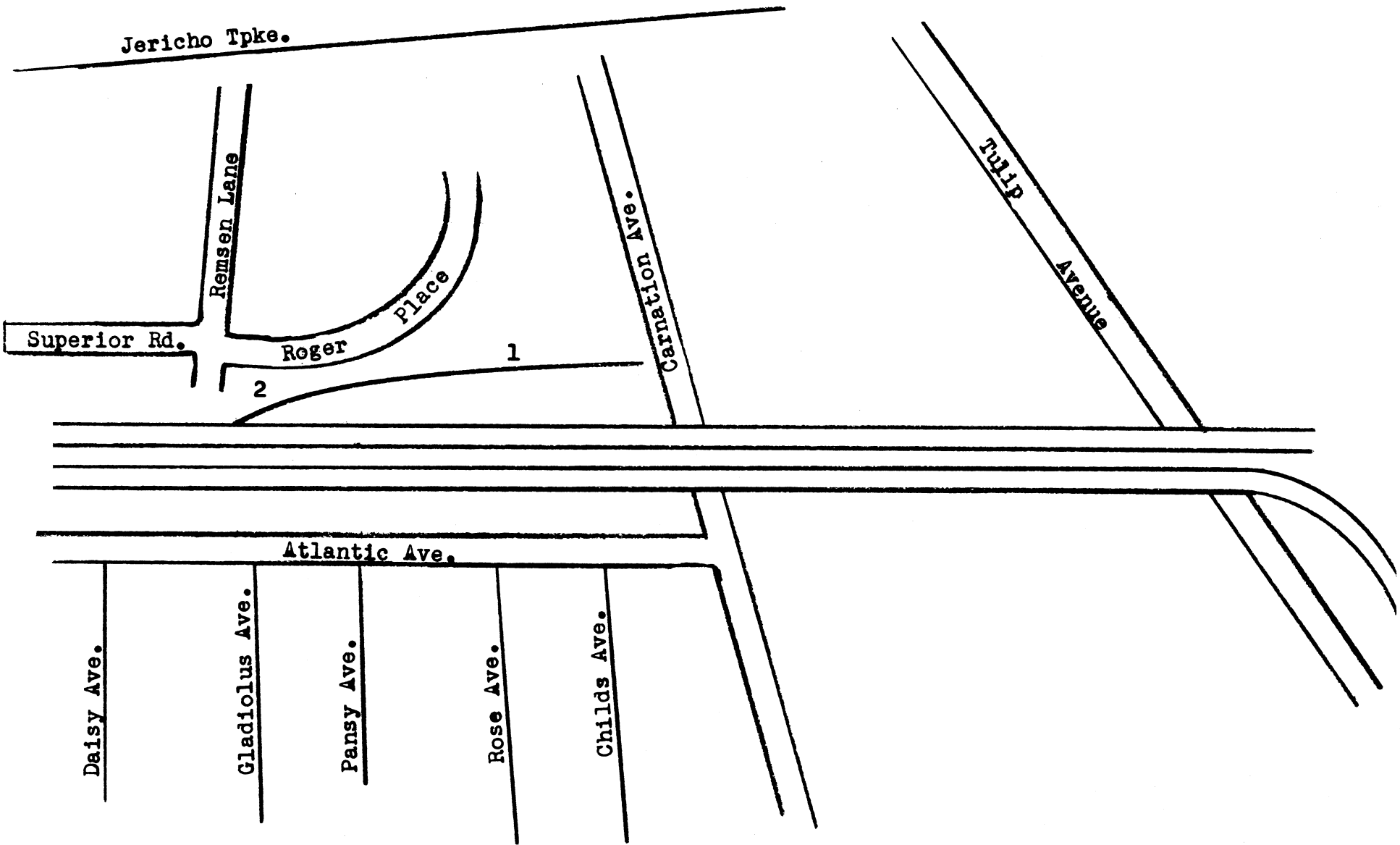

FLORAL PARK

<u>Map Ref.</u>	<u>Consignee</u>	<u>Siding Capacity</u>
1.	Kingsway Plumbing	
2.		

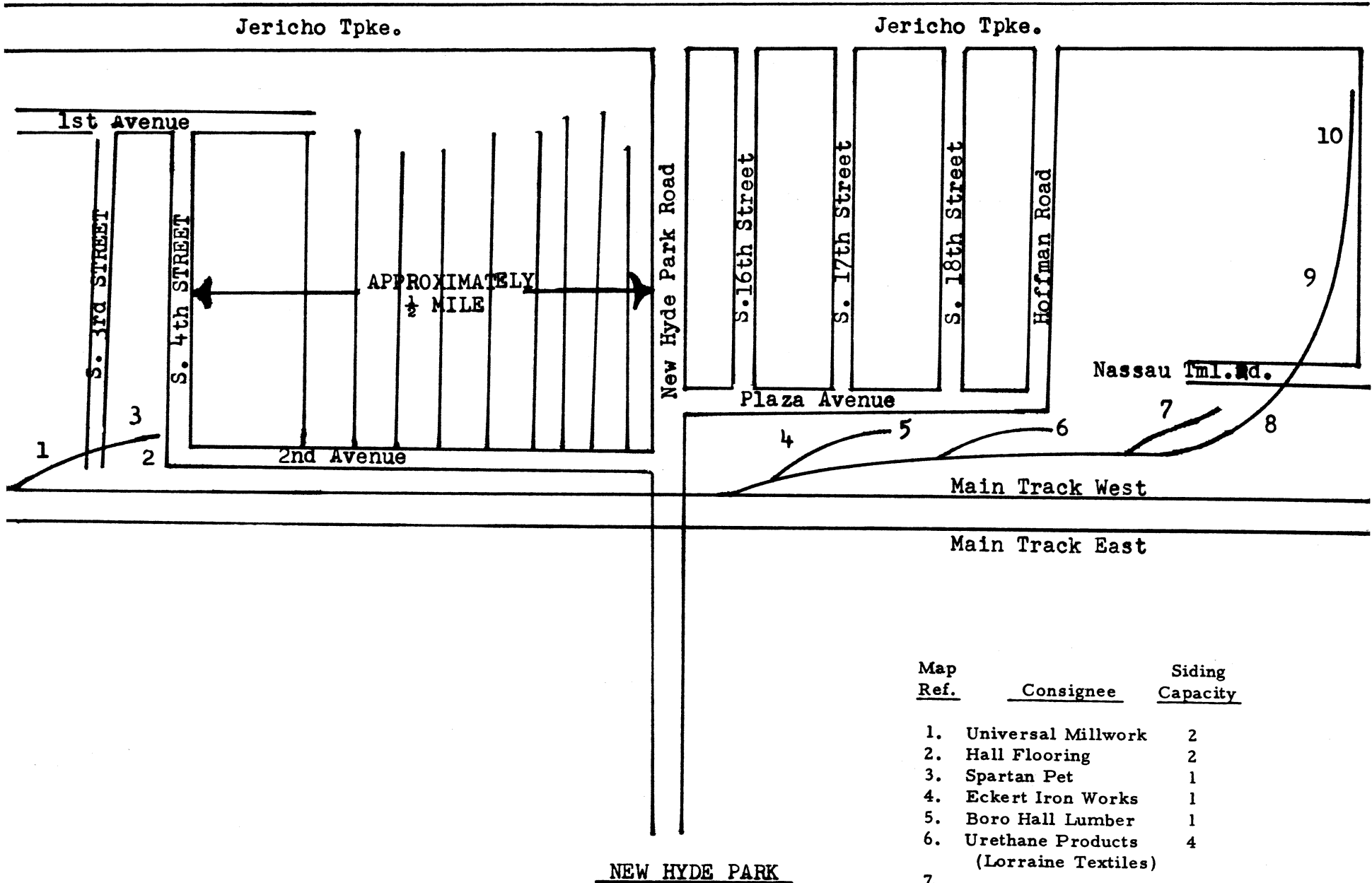

Map Ref.	Consignee	Siding Capacity
1.	Universal Millwork	2
2.	Hall Flooring	2
3.	Spartan Pet	1
4.	Eckert Iron Works	1
5.	Boro Hall Lumber	1
6.	Urethane Products (Lorraine Textiles)	4
7.		
8.	American Strip Steel	2
9.	Chesler Plywood	2
10.	Henry Sash & Door	2

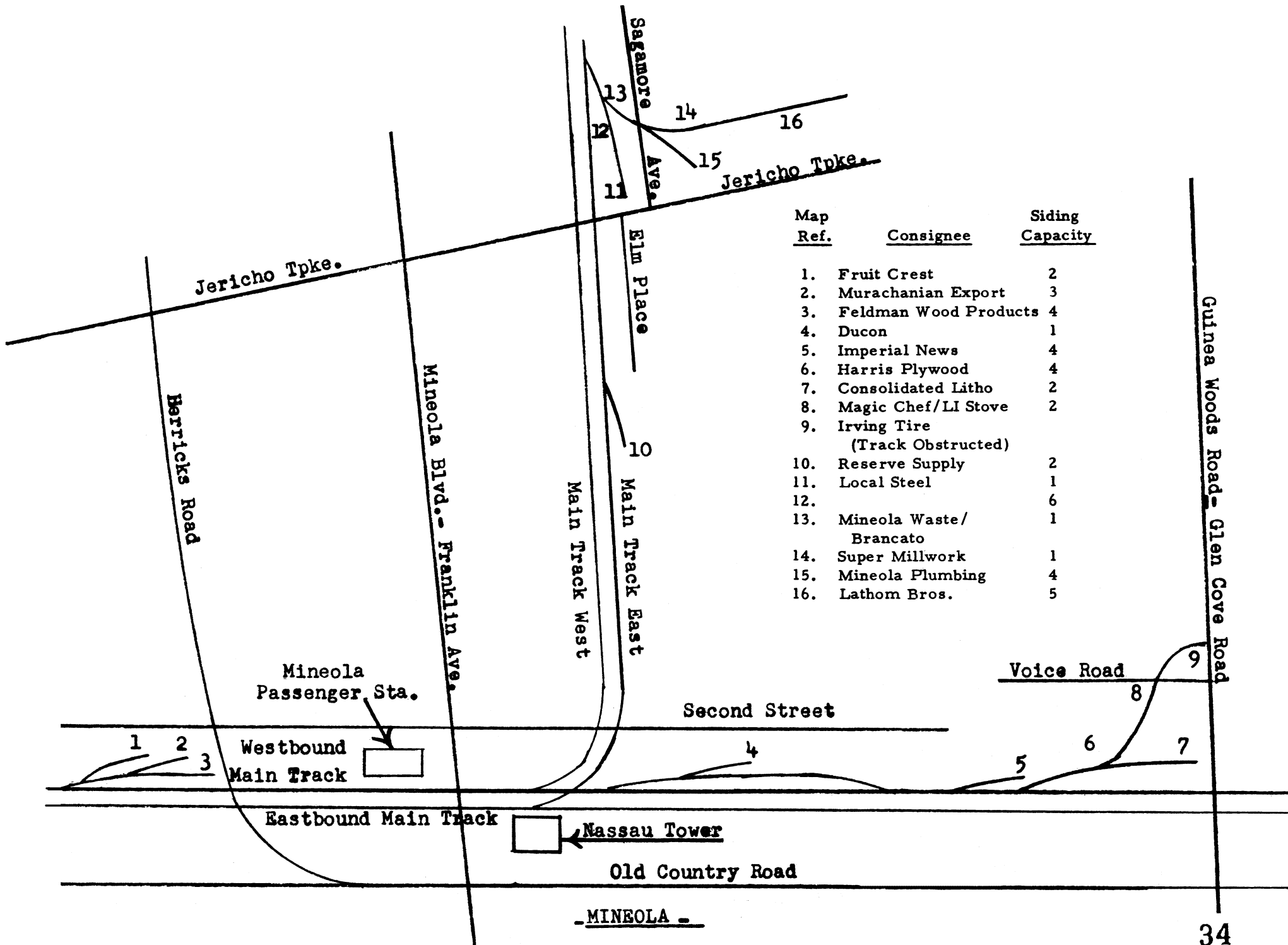

<u>Map Ref.</u>	<u>Consignee</u>	<u>Siding Capacity</u>
1.	Fruit Crest	2
2.	Murachanian Export	3
3.	Feldman Wood Products	4
4.	Ducon	1
5.	Imperial News	4
6.	Harris Plywood	4
7.	Consolidated Litho	2
8.	Magic Chef/LI Stove	2
9.	Irving Tire (Track Obstructed)	
10.	Reserve Supply	2
11.	Local Steel	1
12.		6
13.	Mineola Waste/ Brancato	1
14.	Super Millwork	1
15.	Mineola Plumbing	4
16.	Lathom Bros.	5

- MINEOLA -

Old Country Road

Map Ref.	Consignee	Siding Capacity
1.	Oxford Pendaflex	4
2.	Newsday	5
3.	A & P	4
4.	Borus Bros.	2
5.	Hampton Sales	1
6.	Team Tracks	
7.		
8.	Storage Tracks	
9.	Continental Extrusion	3
10.	Navy Annex	
11.	Lee Story of Nassau	4
12.	Master Millwork	1
13.	Global Frozen Foods/ Garden City Refrigeration	5
14.	Mercury Litho/ Georgian Webb	7
15.		
16.	Garden City Paper	1
17.	Grumman	

Clinton Road- Glen Cove Road

Zeckendorf Blvd.

East Gate Blvd.

Roosevelt Field

Stewart Ave.

Mineola Frt. House

Commercial Ave. 16 South Siding

Garden City

Oak Street

South Street

Endo Drive

(Official name of freight station is Mineola-Garden City)

15

14

13

17

2

1

3

4

5

6

7

8

9

11

12

35

10

ROSLYN

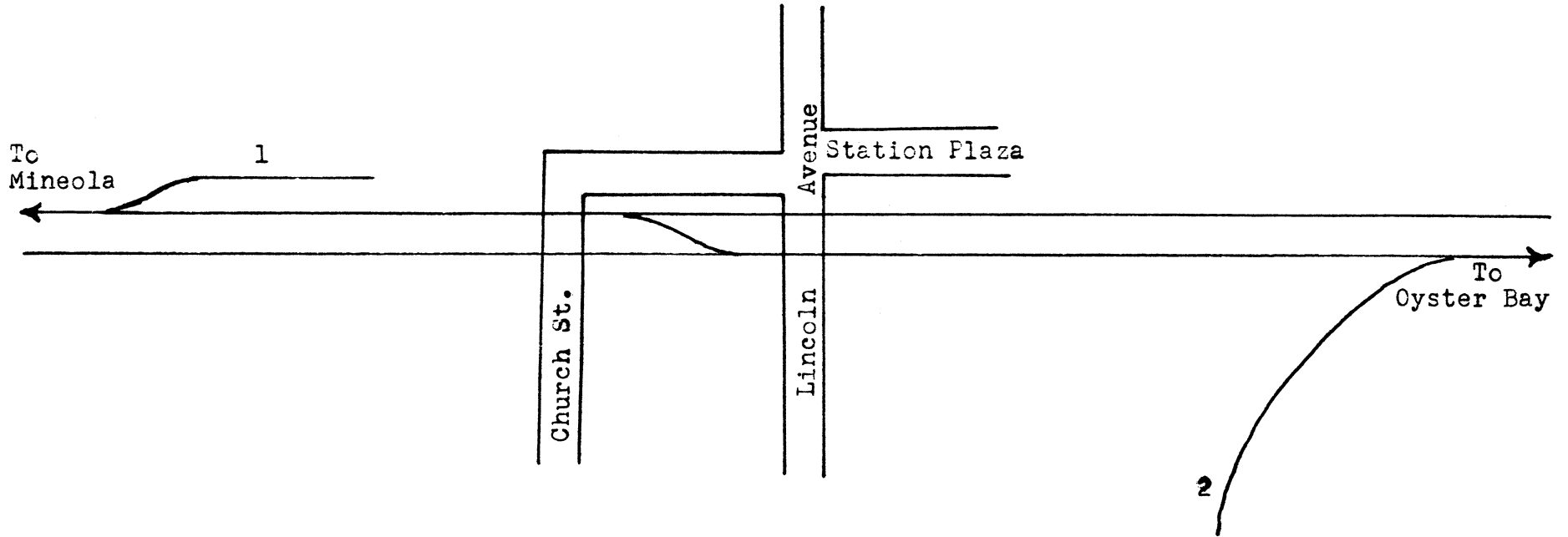

<u>Map Ref.</u>	<u>Consignee</u>	<u>Siding Capacity</u>
1.	M of W Siding	
2.	Helena Rubenstein	2

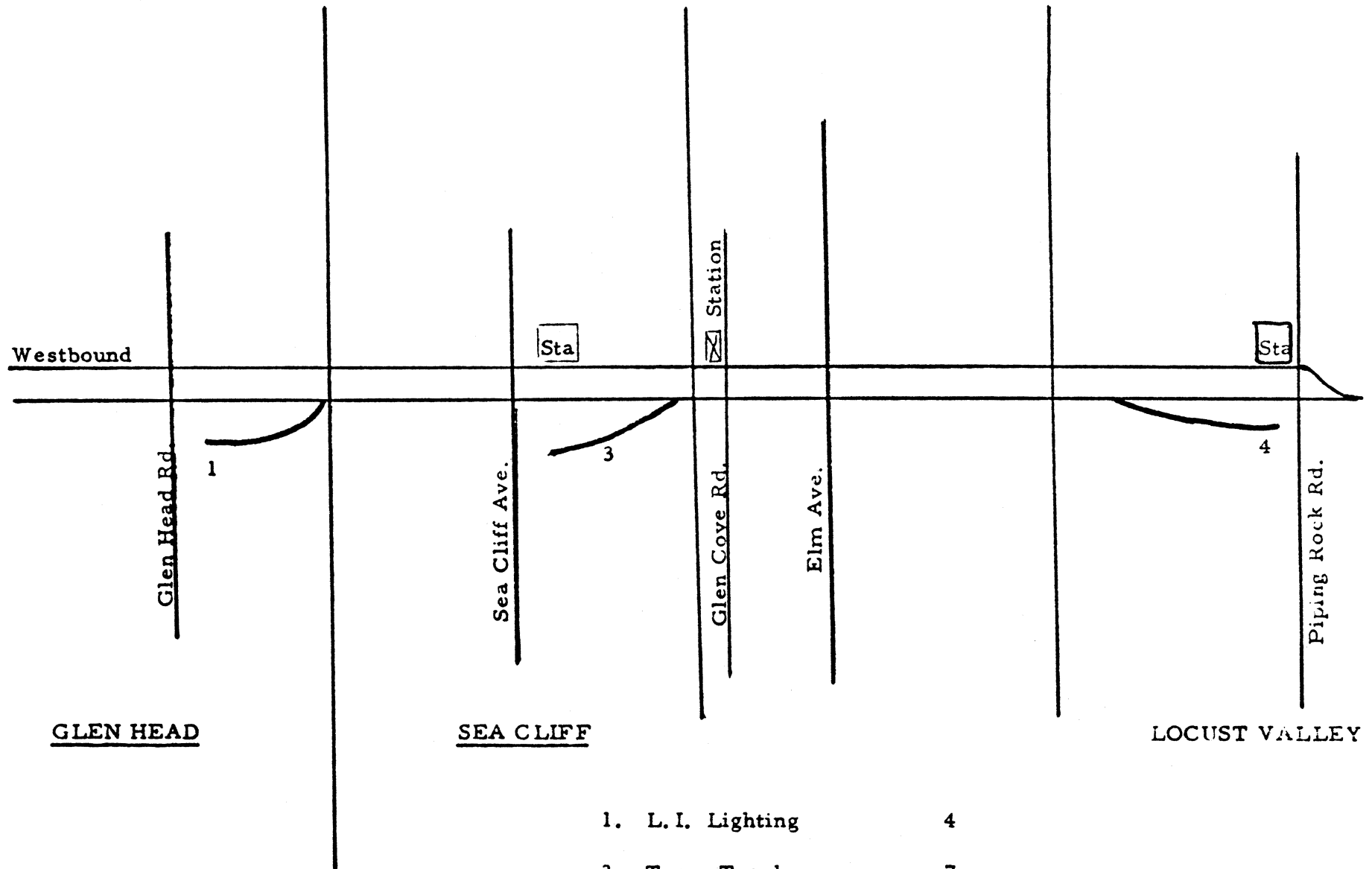

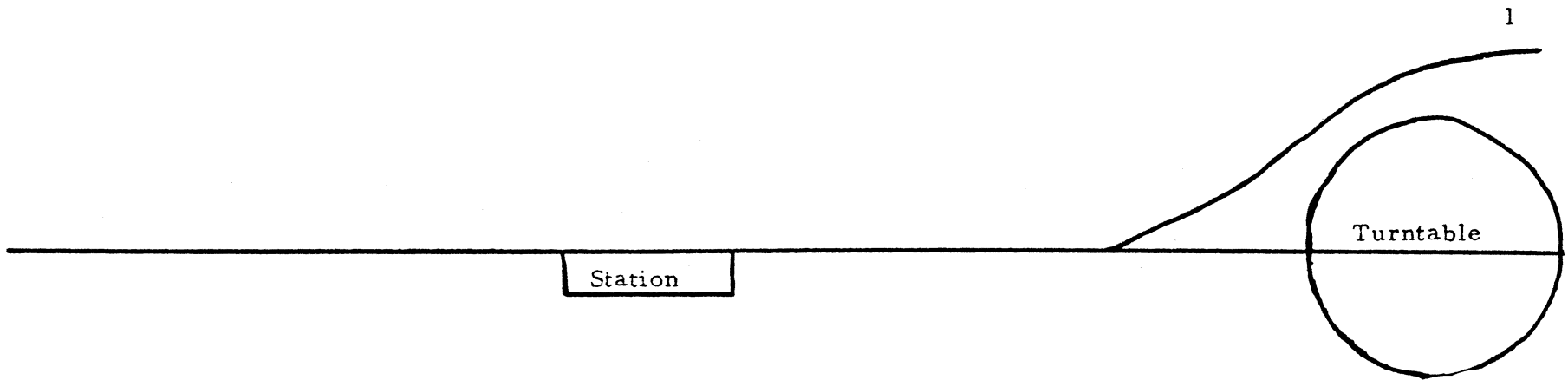

<u>Consignee</u>	<u>Track Capacity</u>
1. Oyster Bay Lbr	1

OYSTER BAY

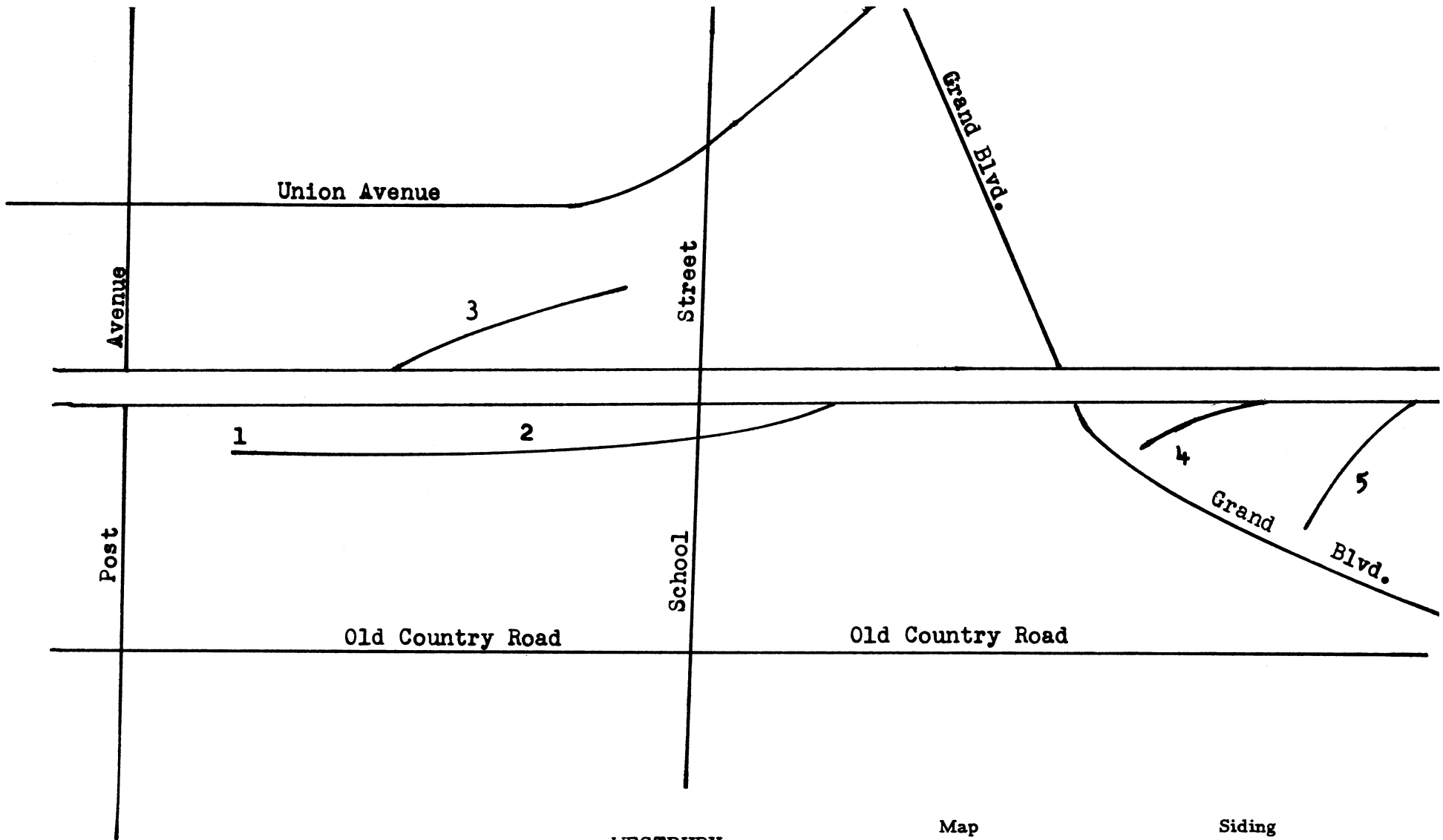

WESTBURY

<u>Map Ref.</u>	<u>Consignee</u>	<u>Siding Capacity</u>
1.	Allied Bakers / Nassau Cold Storage	3
2.	Napoli Brothers	
3.	Feldman Lumber	1
4.	Westbury Mason / Astro Ready Mix	9
5.	Friendly Frost	7

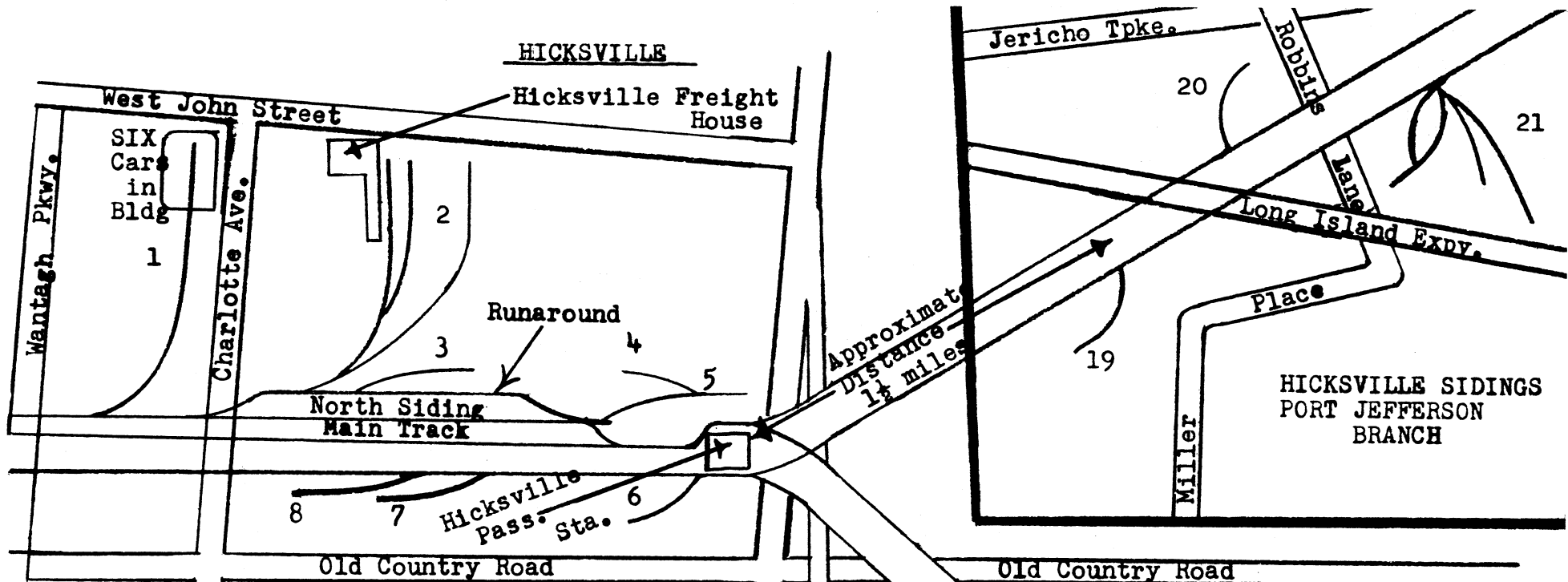

Map Ref.	Consignee	Siding Capacity
1.	King Kullen	6
2.	Team Tracks	
3.	Robinson Lloyd / Harbor Distr.	1
4.	Hudson Berlind	4
5.	Quaker State Oil (National Oil)	1
6.		4
7.	Certified Inds.	8
8.	Certified Inds.	5
9.	LILCO	20
10.	Firestone Plywood	4
11.	Wasserman Bag	4
12.	Ronzoni Foods	3
13.	McKeon Lumber	5
14.	Meadowbrook Paper	2
15.	S. W. Anderson	3
16.	East Coast Millwork	2
17.	R. C. Hooker Chem.	10
18.	Inland Plastics	4
19.	H. E. Schiff Distr.	4
20.	Distron	3
21.	Cerro Wire & Cable	6

<u>Map Ref.</u>	<u>Consignee</u>	<u>Siding Capacity</u>
-----------------	------------------	------------------------

- | | | |
|----|--------------------------------------|----|
| 1. | Great American Corr. Container Corp. | 6 |
| 2. | Star Liquors | 12 |
| 3. | Georgia Pacific | 3 |
| 4. | Georgia Pacific / Hollows Warehouse | 4 |
| 5. | Old Team Track | 5 |
| 6. | Knickerbocker Liquor | 4 |

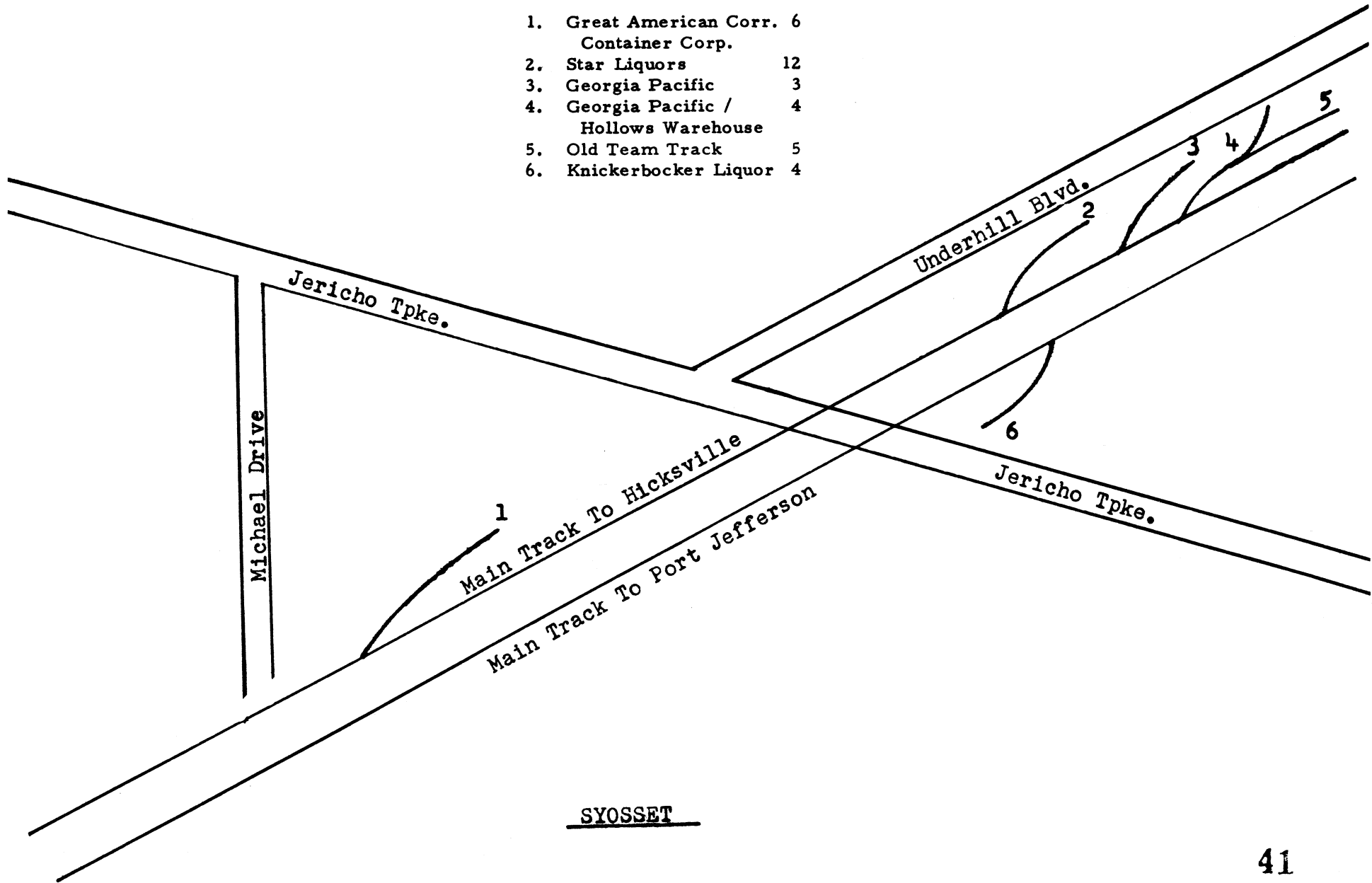

SYOSSET

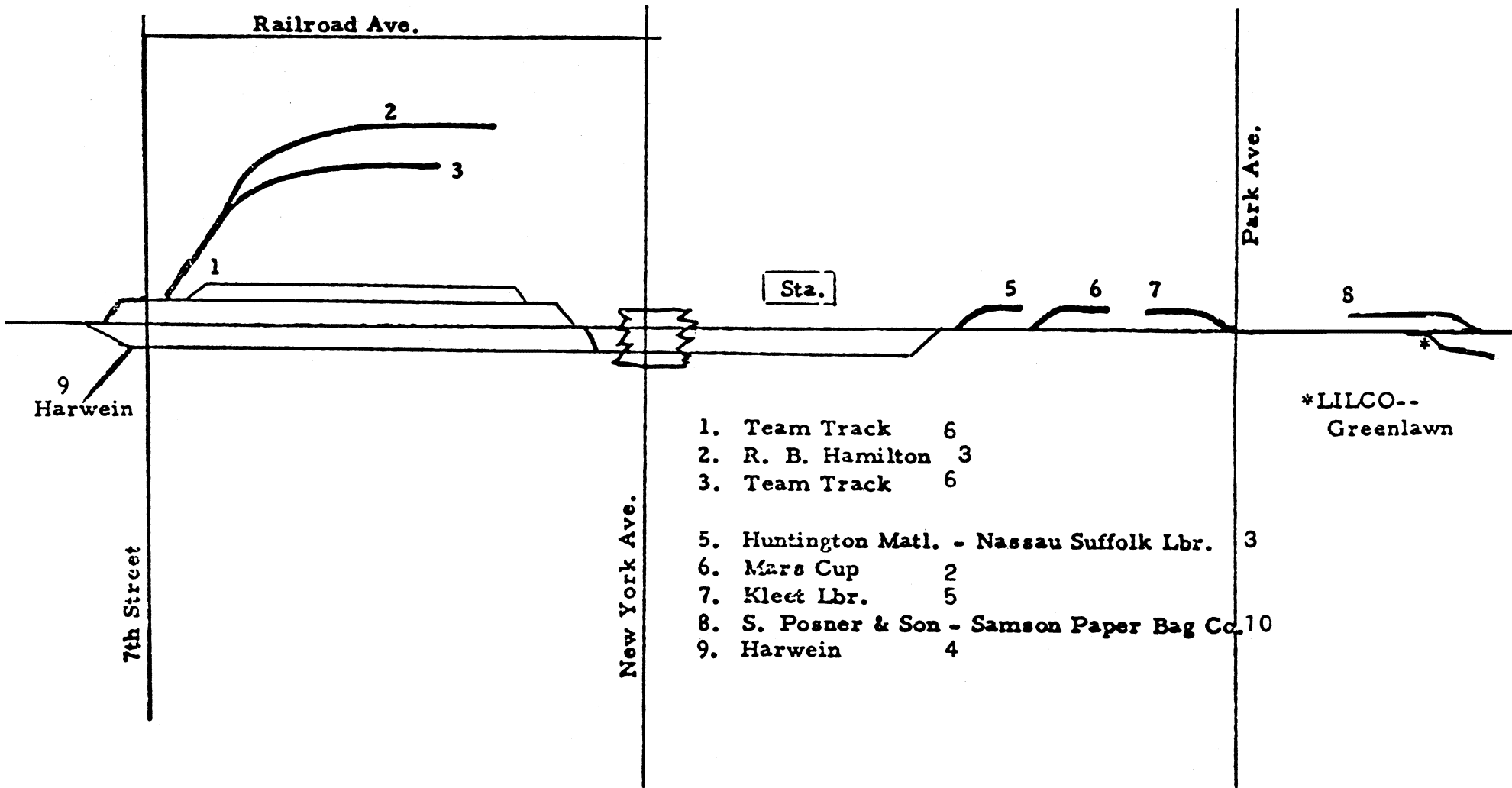

9
Harwein

7th Street

Railroad Ave.

New York Ave.

Sta.

Park Ave.

*LILCO--
Greenlawn

- 1. Team Track 6
- 2. R. B. Hamilton 3
- 3. Team Track 6
- 5. Huntington Matl. - Nassau Suffolk Lbr. 3
- 6. Mars Cup 2
- 7. Klect Lbr. 5
- 8. S. Posner & Son - Samson Paper Bag Co. 10
- 9. Harwein 4

HUNTINGTON

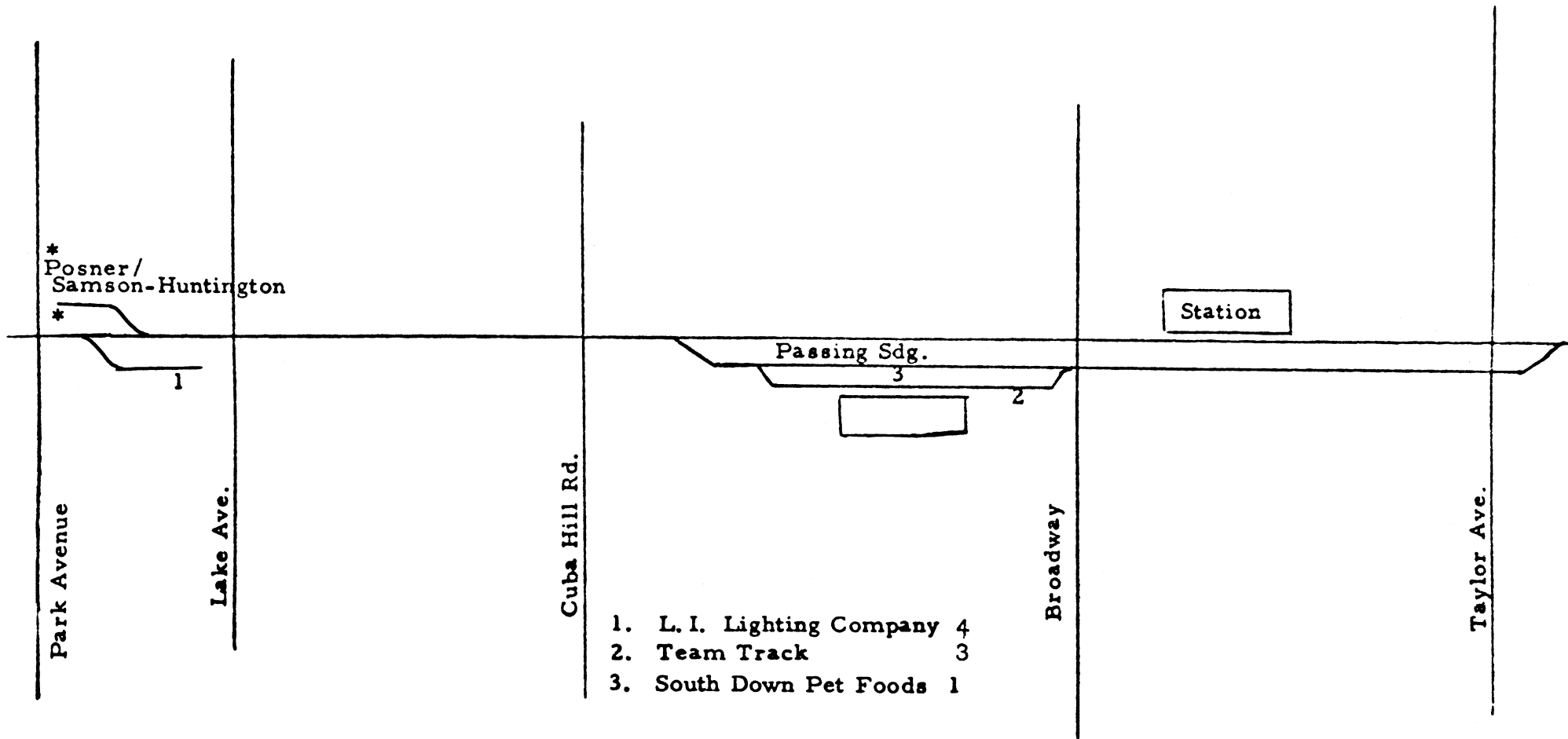

GREENLAWN

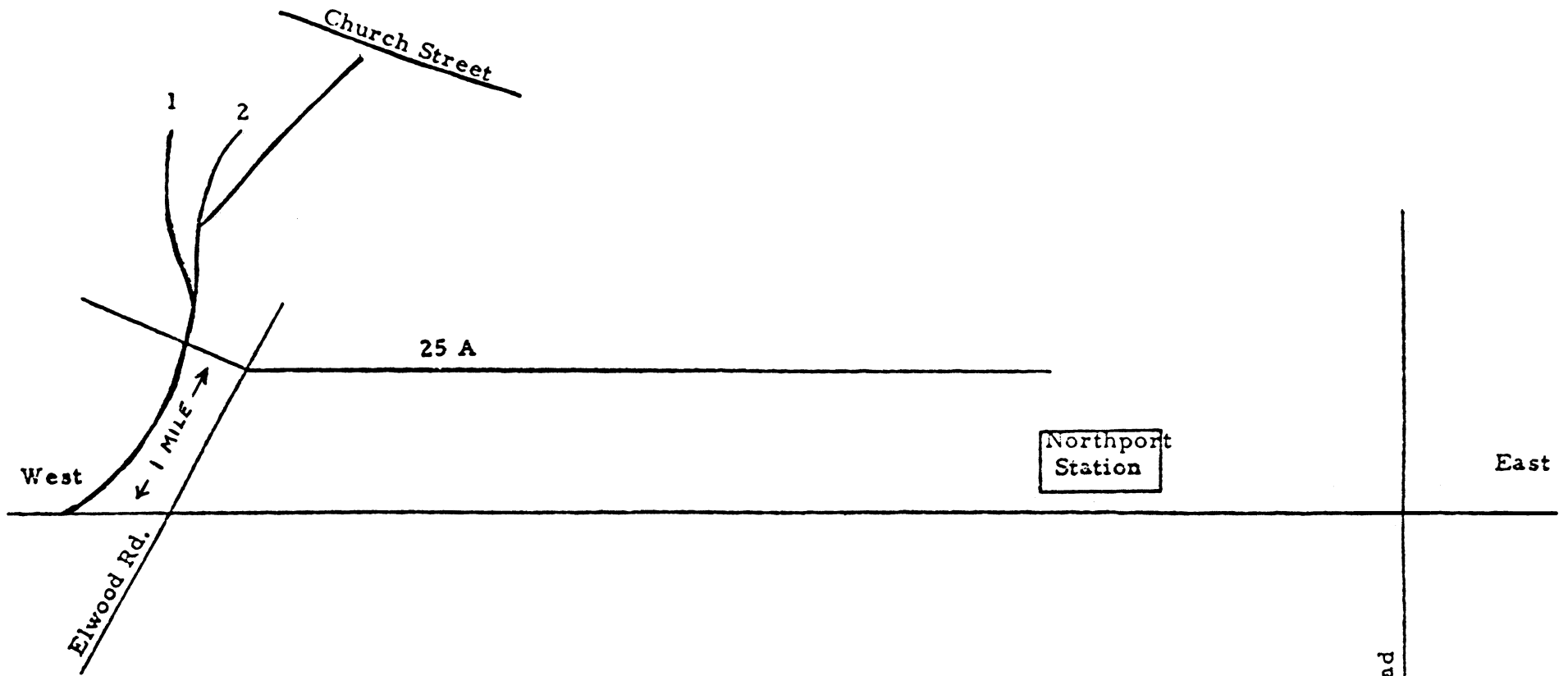

OLD NORTHPORT

	<u>Consignee</u>	<u>Trk. Cap.</u>
1.	Axinn's	5
2.	" "	3

Larkfield Road

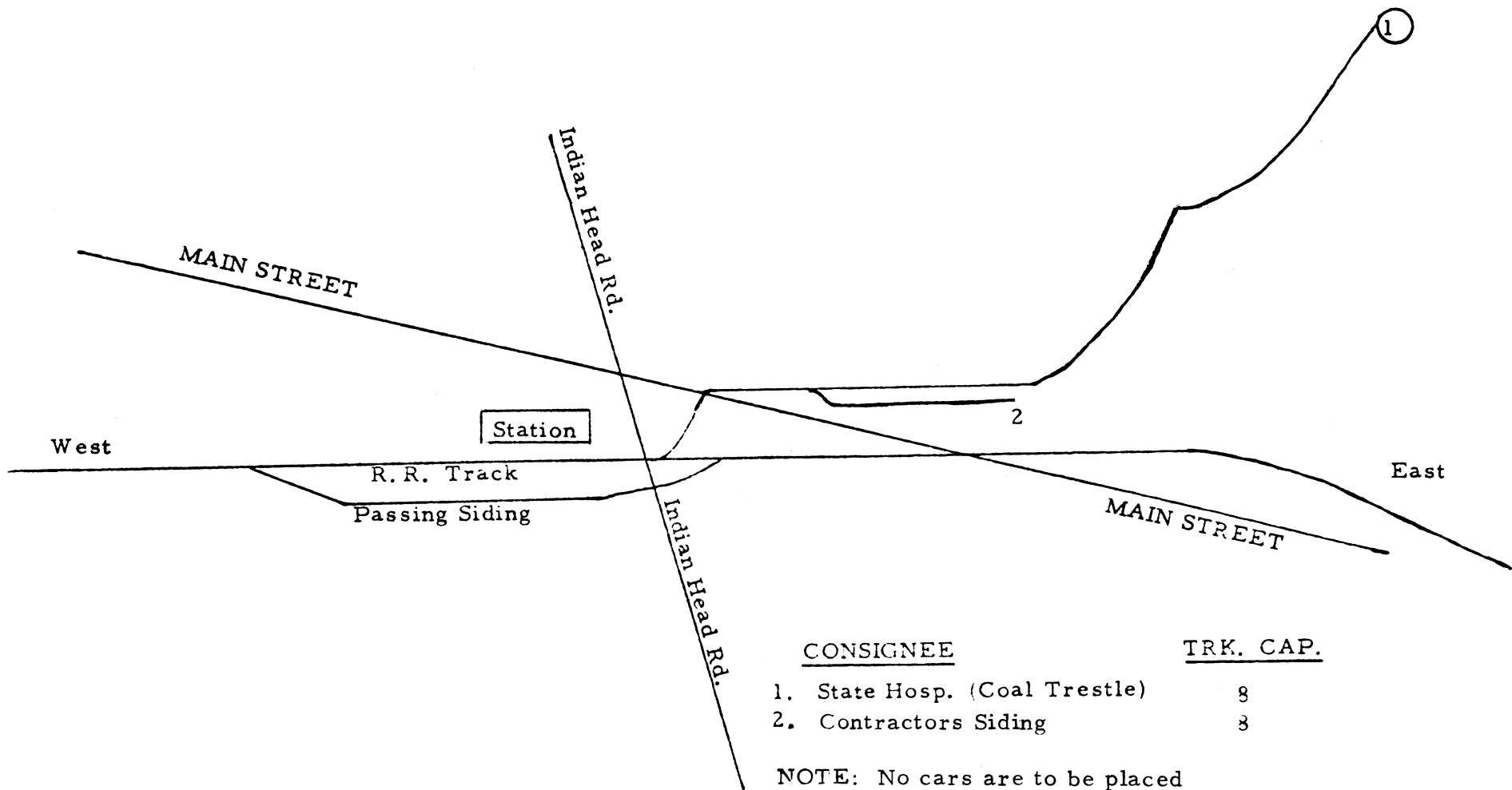

<u>CONSIGNEE</u>	<u>TRK. CAP.</u>
1. State Hosp. (Coal Trestle)	8
2. Contractors Siding	3

NOTE: No cars are to be placed for unloading on lead track to Hospital.

KINGS PARK

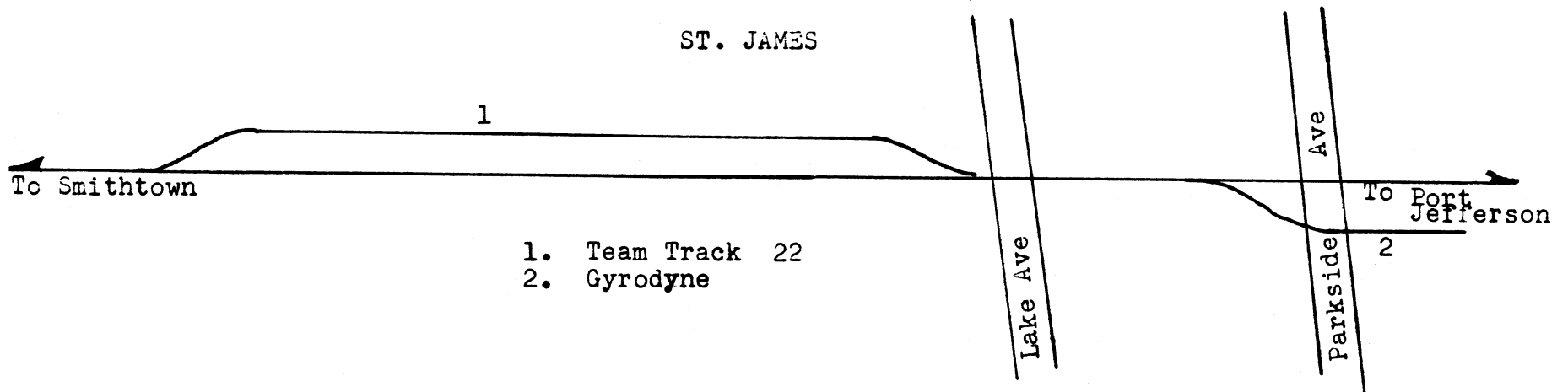
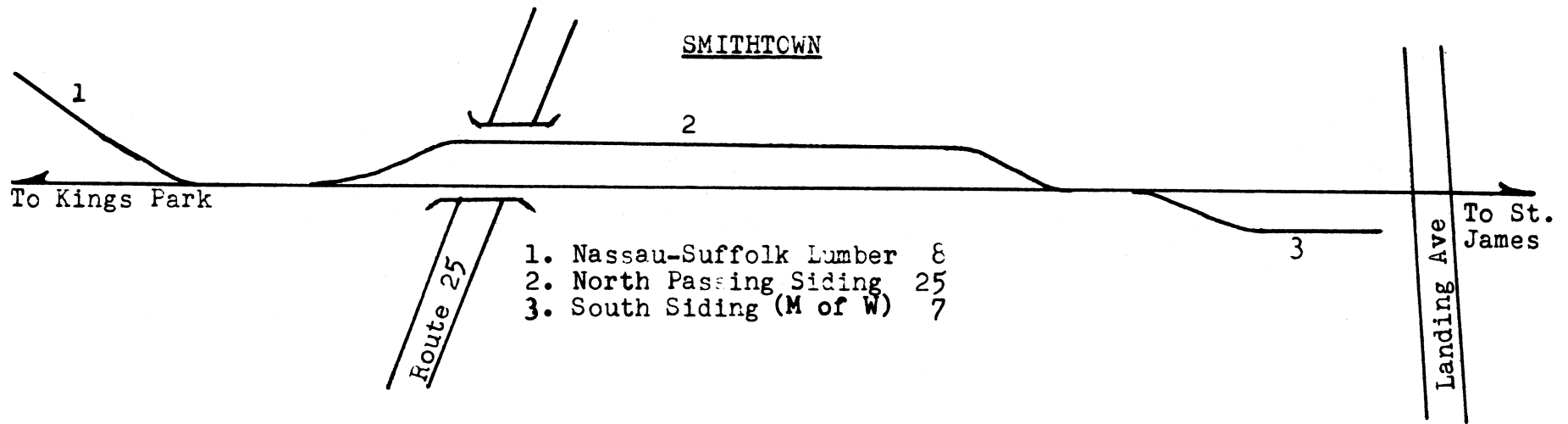

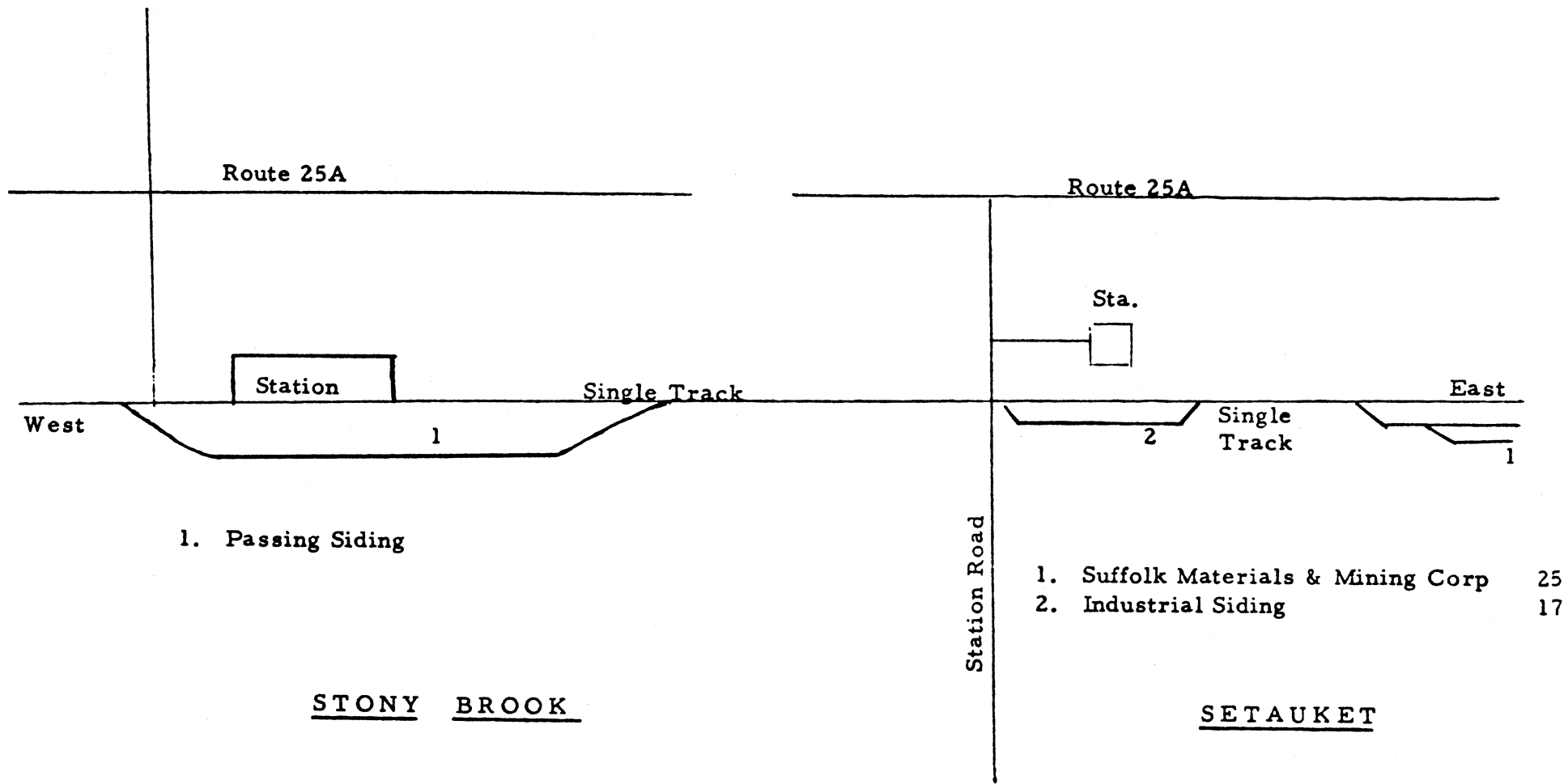

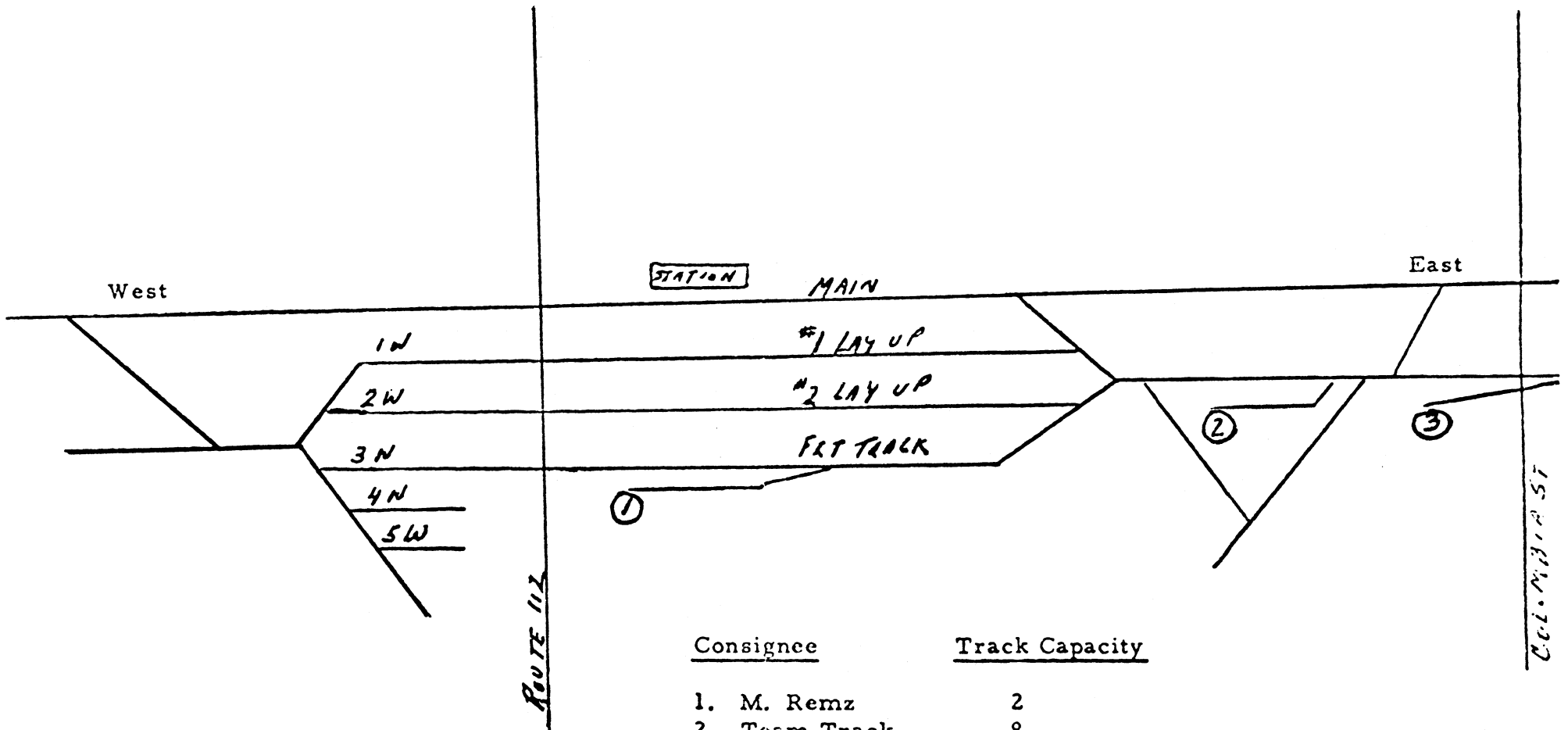

<u>Consignee</u>	<u>Track Capacity</u>
1. M. Remz	2
2. Team Track	8
3. Karvin Lumber	5

PORT JEFFERSON

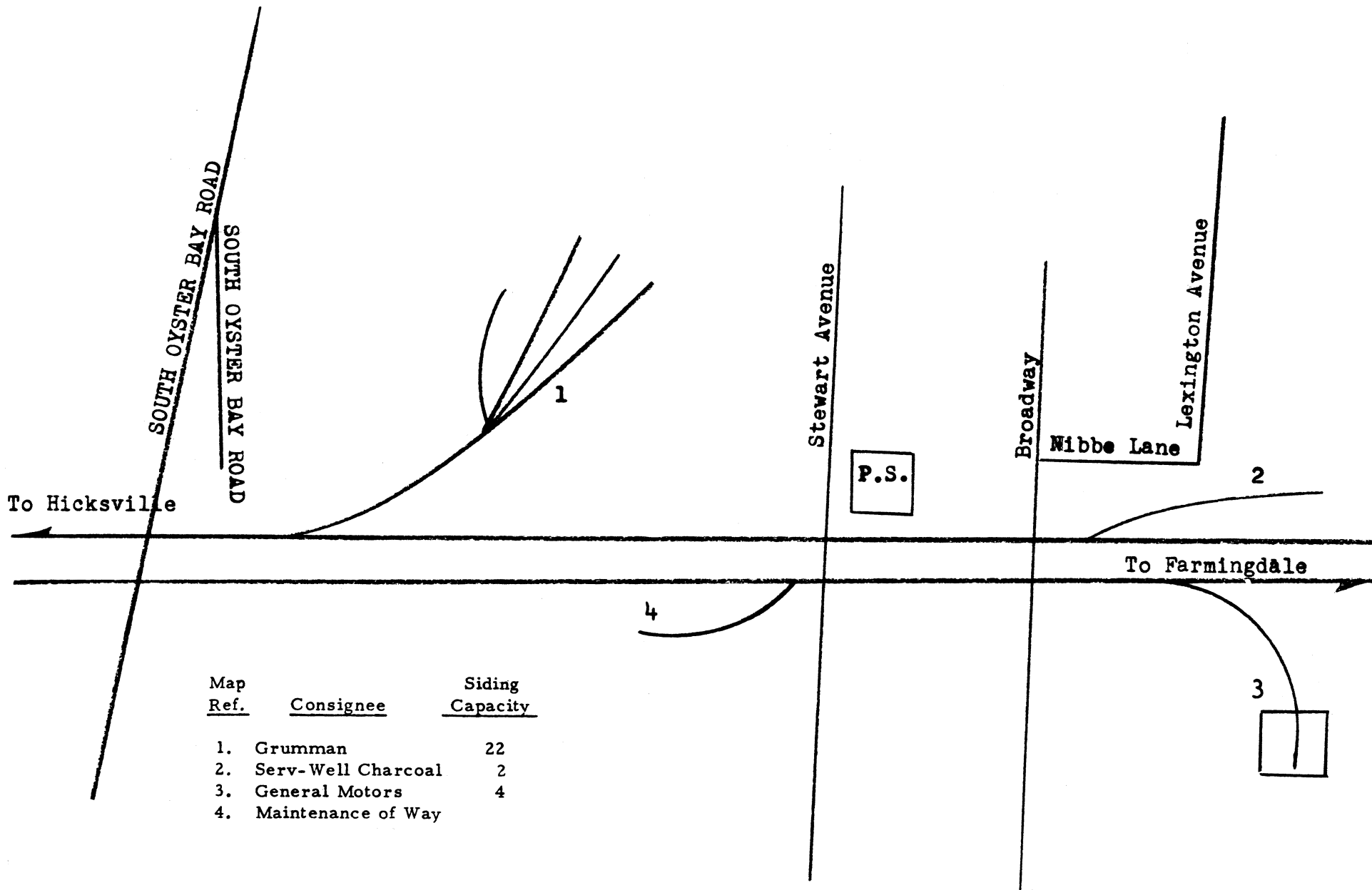

<u>Map Ref.</u>	<u>Consignee</u>	<u>Siding Capacity</u>
1.	Grumman	22
2.	Serv-Well Charcoal	2
3.	General Motors	4
4.	Maintenance of Way	

BETHPAGE

FARMINGDALE

<u>Map Ref.</u>	<u>Consignee</u>	<u>Siding Capacity</u>
-----------------	------------------	------------------------

- | | | |
|-----|--|------------|
| 1. | Wagner Brothers | 3 |
| 2. | Plygem /
Industrial Plywood | 1 |
| 3. | Capital Warehouse | 3 |
| 4. | J. C. Penny | 3 |
| 5. | Sears Roebuck | 5 |
| 6. | Sears Roebuck | 5 |
| 7. | Elk Warehouse | 2 |
| 8. | Weyerhauser (Roddis) | 5 |
| 9. | Packard Flooring | 1 |
| 10. | Brown Osler | 2 |
| 11. | White Rose (Met Food) | 16 |
| 12. | Levitz | 6 |
| 13. | Greenman Brothers | 3 |
| 14. | J & S Trucking /
Farmingdale Mat'l.
Handling | 5 |
| 15. | Team Track | 8 |
| 16. | Team Track | 8 |
| 17. | Fairchild Republic | 6 |
| 18. | Champion Bldg. Prods. | 3 (3 Lead) |
| 19. | American Millwork /
J & H Kitchen Cabinet | 4 |
| 20. | Macrose | 5 |
| 21. | Leopold | 1 |

Segatogue Avenue

Route 110 - Broadhollow Road

New Highway

Conklin Avenue

P.S.

DEPOT RD.

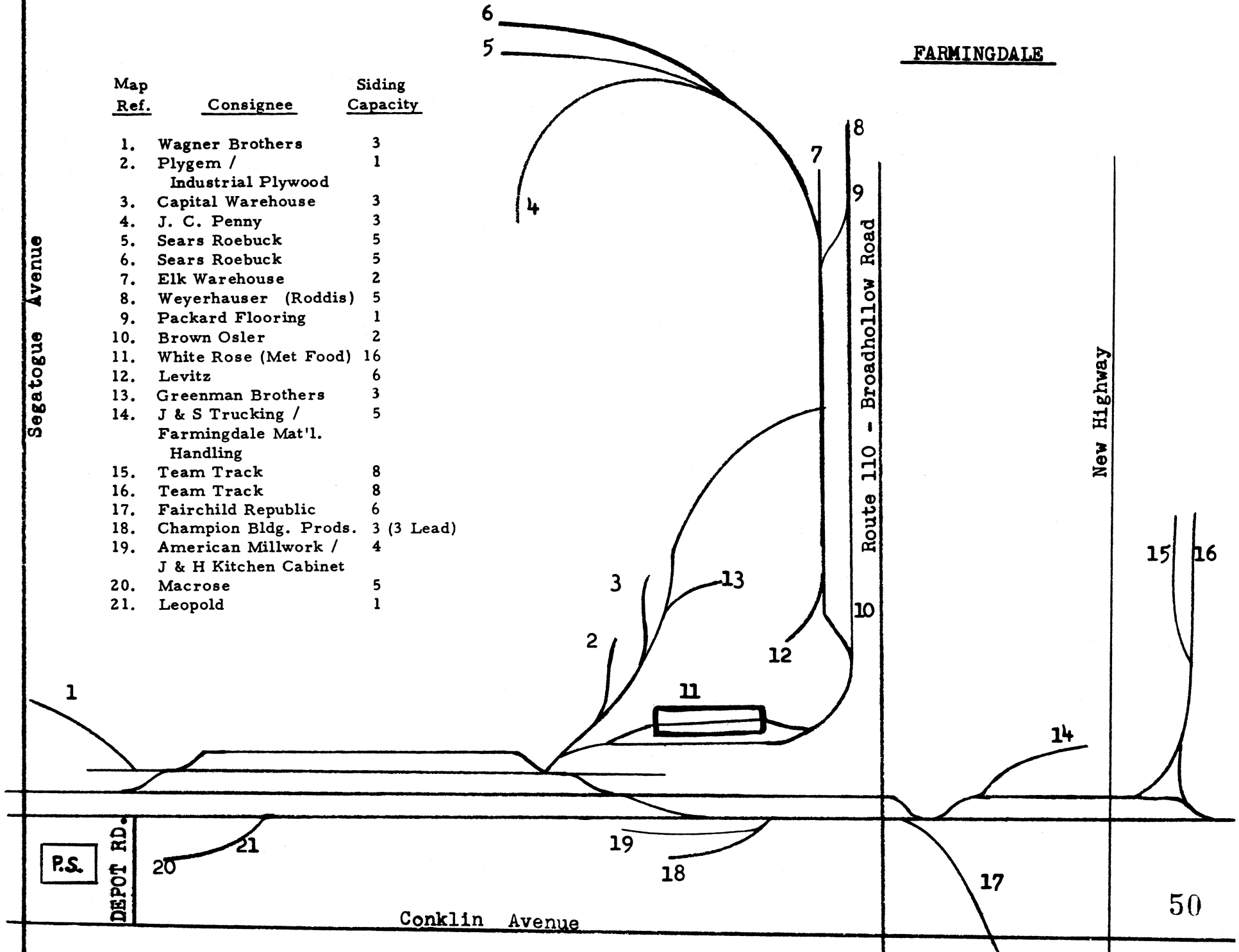

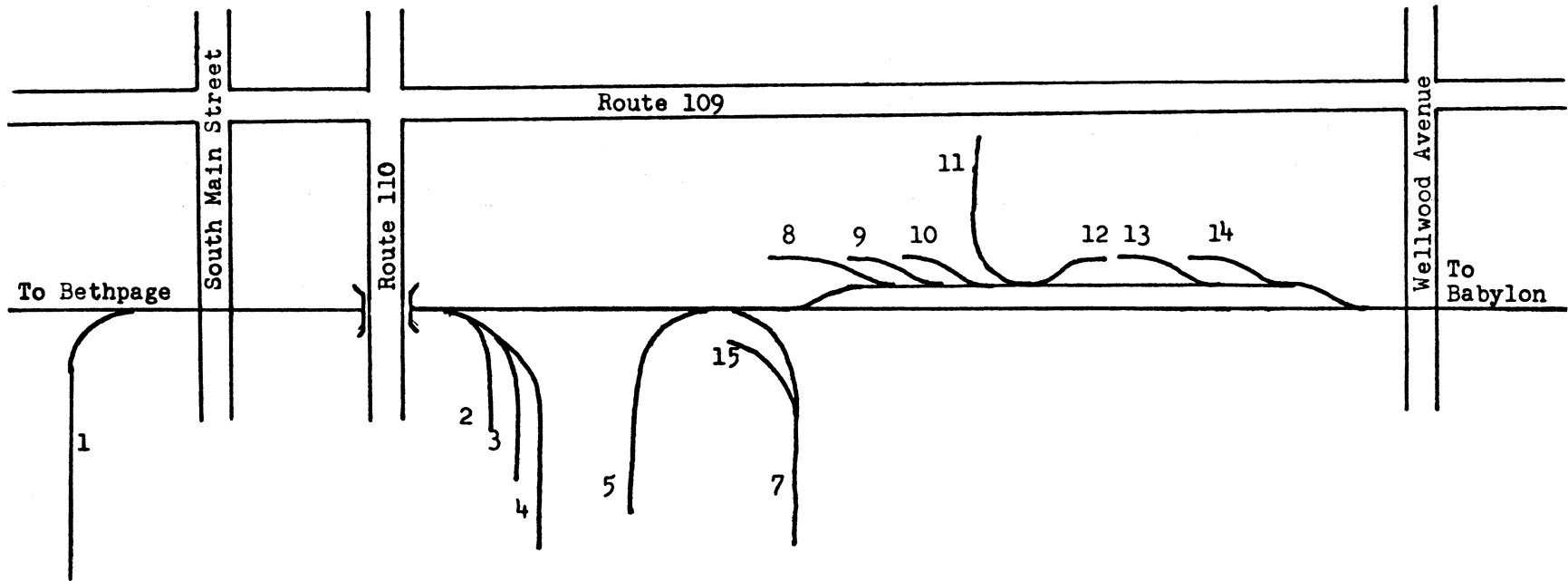

FARMINGDALE - CENTRAL BRANCH

- | | | | | | |
|----|-------------------------|---|-----|--------------------------|---|
| 1. | Liberty Industrial Park | 8 | 9. | Long Island Baking | 3 |
| | Weather Craft Mfg. Co. | | | Long Island Cold Storage | 3 |
| | Woodhewn | | 10. | Boening Brothers | 3 |
| | Universal Millwork | | 11. | Porch & Patio | |
| | American Lumber | | | American Metal Finish | 3 |
| | Fibreglass Resources | | | TAC Carpet Dist. | |
| 2. | Amco Plastic | 2 | 12. | Sprung Monument | 1 |
| 3. | Amco Plastic | 2 | | Farmingdale Granite | |
| 4. | Amco Plastic | | 13. | Van Roy Millwork | 1 |
| | Del Labs | 2 | 14. | Keith Machine | 4 |
| | Maradez | | 15. | Polymer | 6 |
| 5. | Midway Beverage | 3 | | | |
| 6. | | | | | |
| 7. | Polymer | 3 | | | |
| 8. | Medalion Pool | | | | |
| | Stratford Assoc. | | | | |
| | Sigma Packing | 2 | | | |
| | County Dump | | | | |
| | Alpro Supply | | | | |
| | Cee Jay Extruders | | | | |
| | Merit Assoc | | | | |

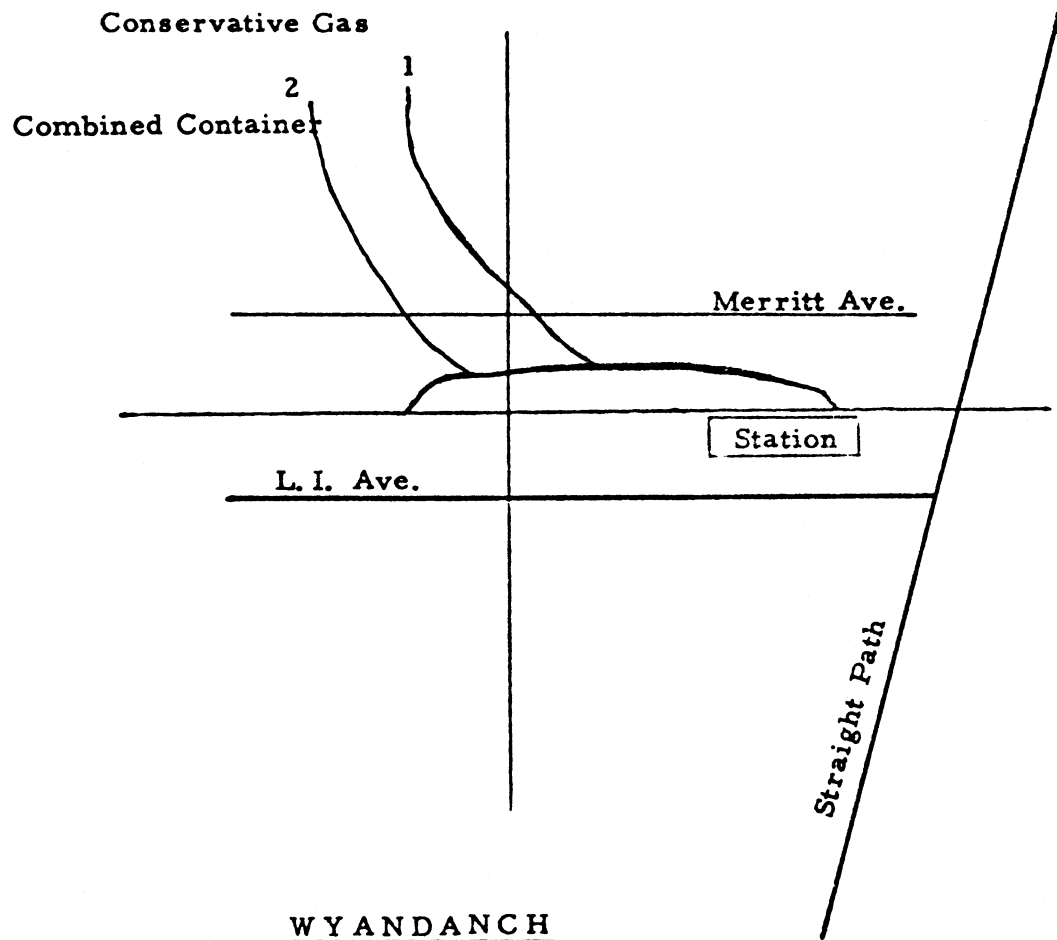

WYANDANCH

1. CONSERVATIVE GAS 5

2. COMBINED CONTAINER 3

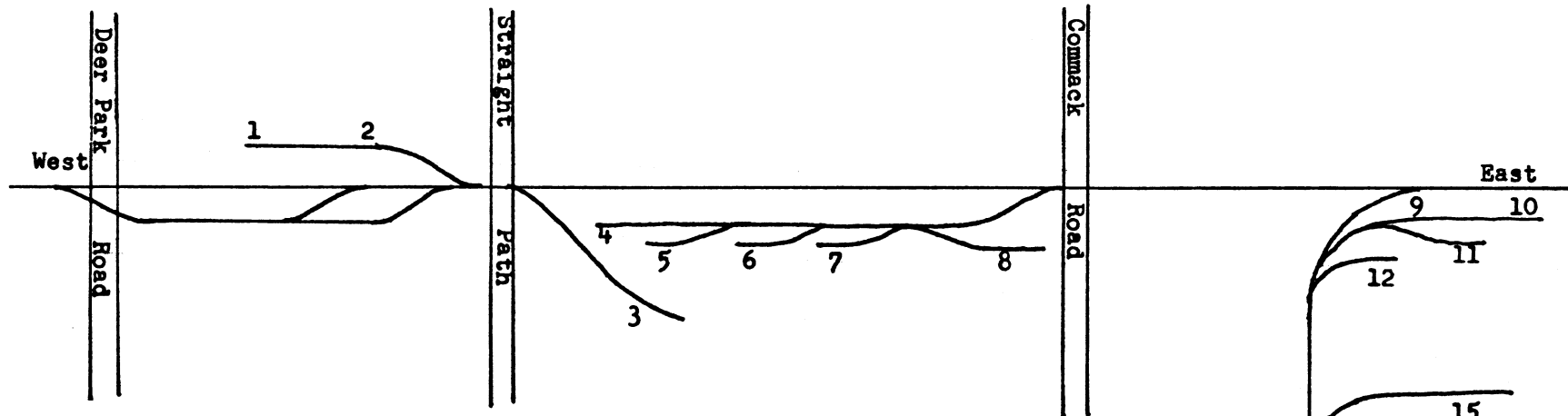

DEER PARK

- | | | |
|-----|----------------------------------|----|
| 1. | Team Track | 6 |
| 2. | Boro Lumber | 2 |
| 3. | Pinter Brothers | 11 |
| 4. | Marcus Assoc
Sanitary Control | |
| 5. | Long Island Macaroni | 2 |
| 6. | Accurate Web | 2 |
| 7. | American Leisure | |
| 8. | Eldee Appliance | 2 |
| 9. | D. E. Axinn | |
| 10. | Quintree Dist. | 3 |
| 11. | Sturtivent Millwork | 2 |
| 12. | Hewnrite Industries | 2 |
| 13. | Georgetown Manor | 2 |
| 14. | Southern Container | 8 |
| 15. | Sabbeth Lumber | 5 |

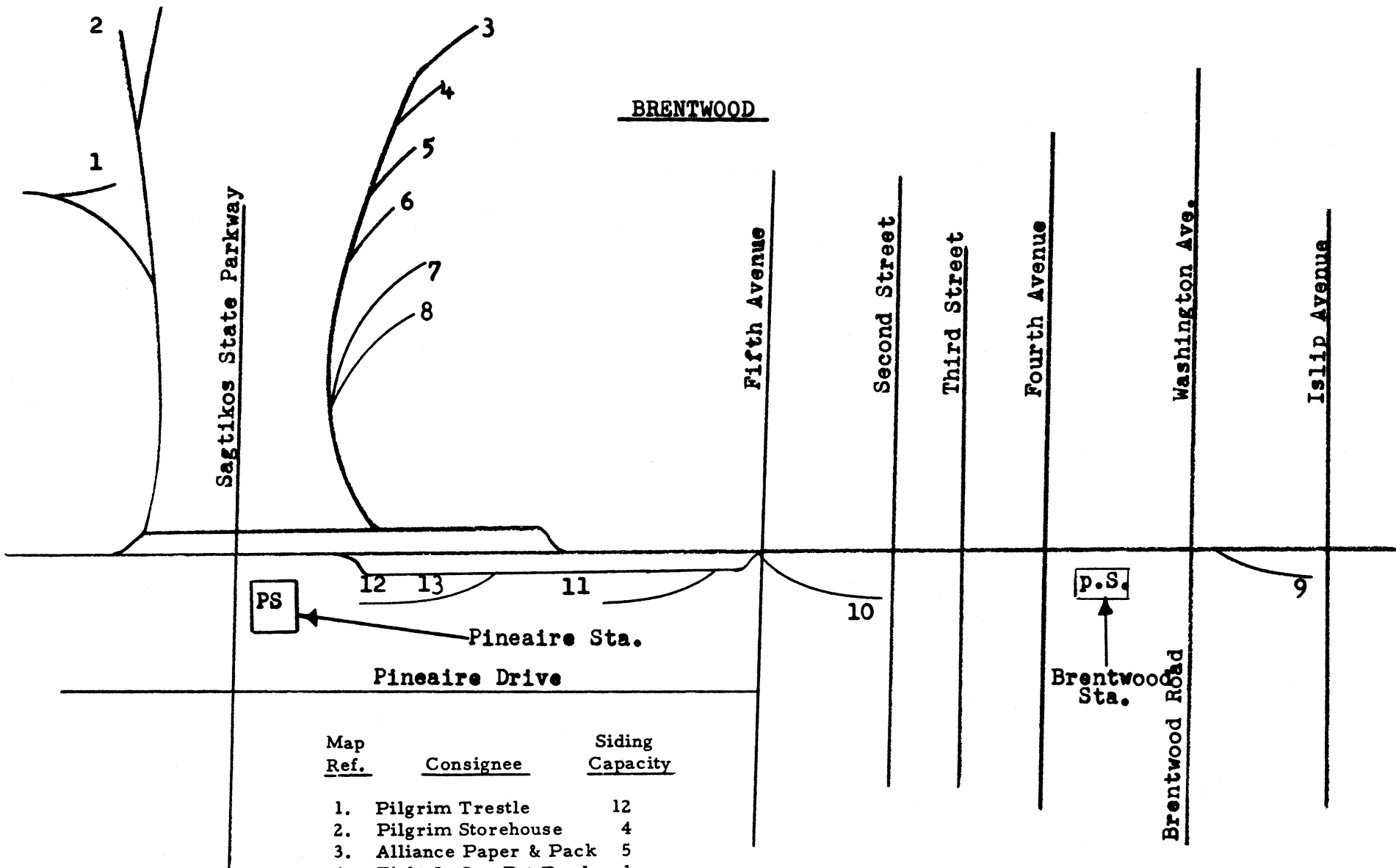

<u>Map Ref.</u>	<u>Consignee</u>	<u>Siding Capacity</u>
1.	Pilgrim Trestle	12
2.	Pilgrim Storehouse	4
3.	Alliance Paper & Pack	5
4.	Eight In One Pet Prods.	1
5.	Carnation Paper	3
6.	Thompson Tire & Arbor Plywood	3
7.		12
8.		7
9.	L. I. Lighting	8
10.	Brentwood Lumber	2
11.	Equitable Lumber	5
12.	Nash Lumber	2
13.	Reserve Supply	4

CENTRAL ISLIP

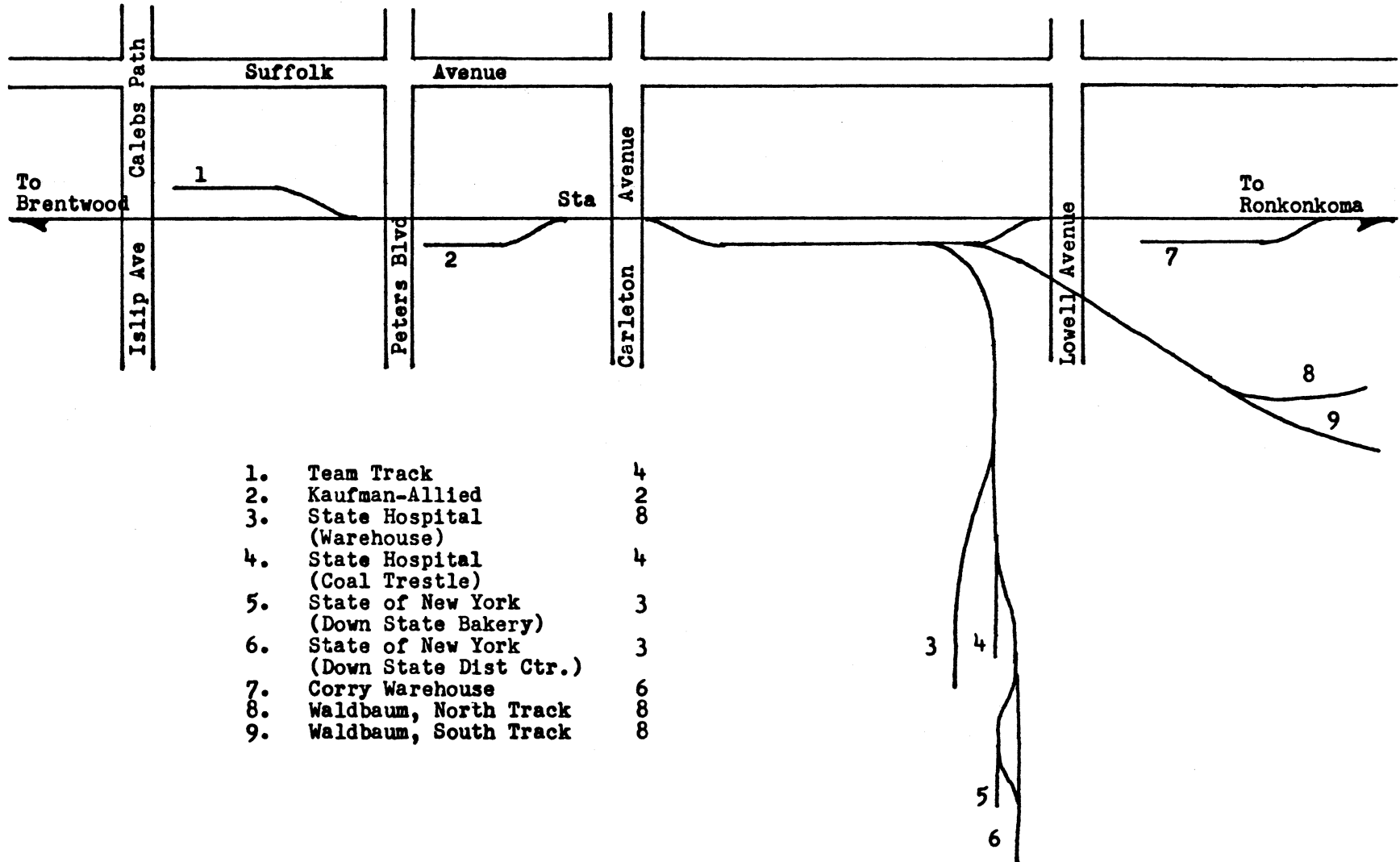

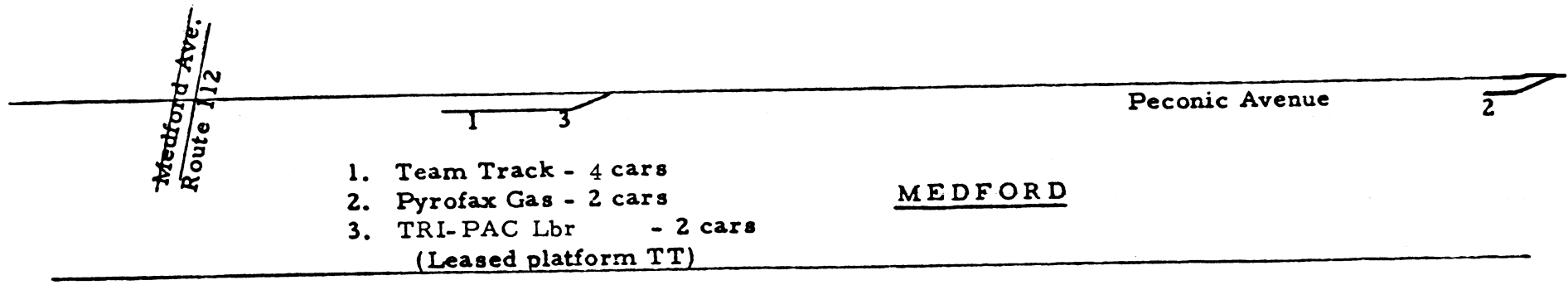

1. Team Track - 4 cars
2. Pyrofax Gas - 2 cars
3. TRI-PAC Lbr - 2 cars
(Leased platform TT)

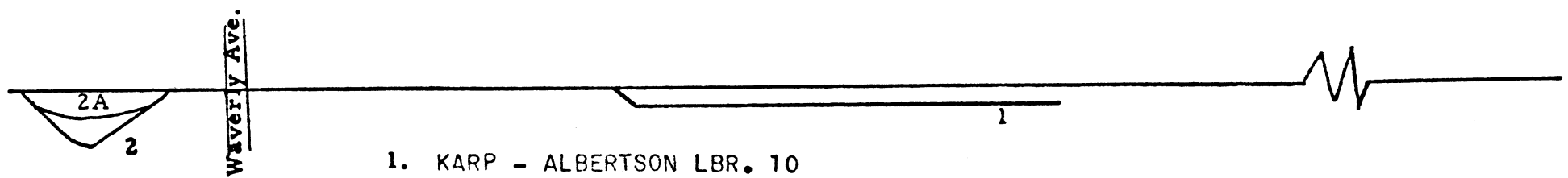

1. KARP - ALBERTSON LBR. 10
2. Prima Asphalt - 45 cars
- 2A. " " - 45 cars

Capacity

- | | |
|------------------|----|
| 1. Ash Pit Track | 20 |
| 2. Team Track | 5 |
| 3. #2 Track | 11 |

Capacity

- | | |
|---------------|----|
| 4. #1 Track | 14 |
| 5. No. Siding | 18 |
| 6. So. Siding | 40 |
| 7. Verby | 5 |

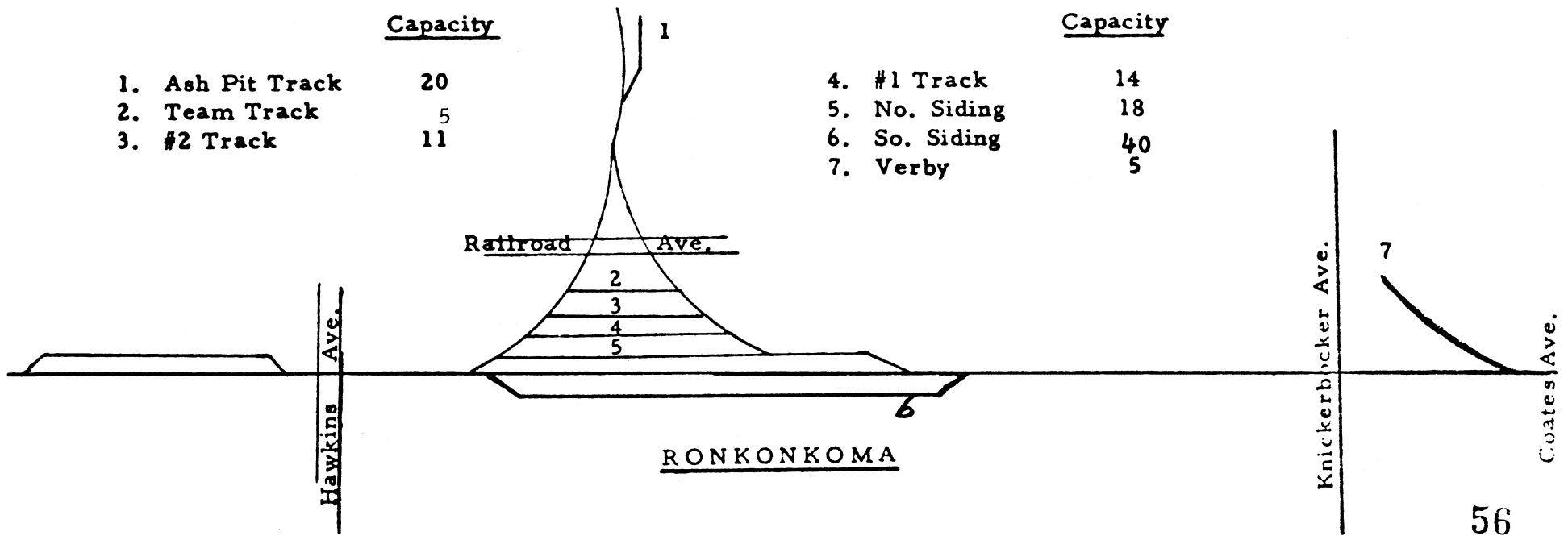

YAPHANK

- | | | |
|----|----------------------------|----|
| 1. | Georgia Pacific | 5 |
| 2. | Accent Flooring | 1 |
| 3. | Team Track | 5 |
| 4. | Passing Track | |
| 5. | Brookhaven Labs Track 1 | 44 |
| 6. | Brookhaven Labs Track 2 | 32 |
| 7. | Brookhaven Labs Track 3 | 32 |
| 8. | Brookhaven Labs Tail Track | 30 |

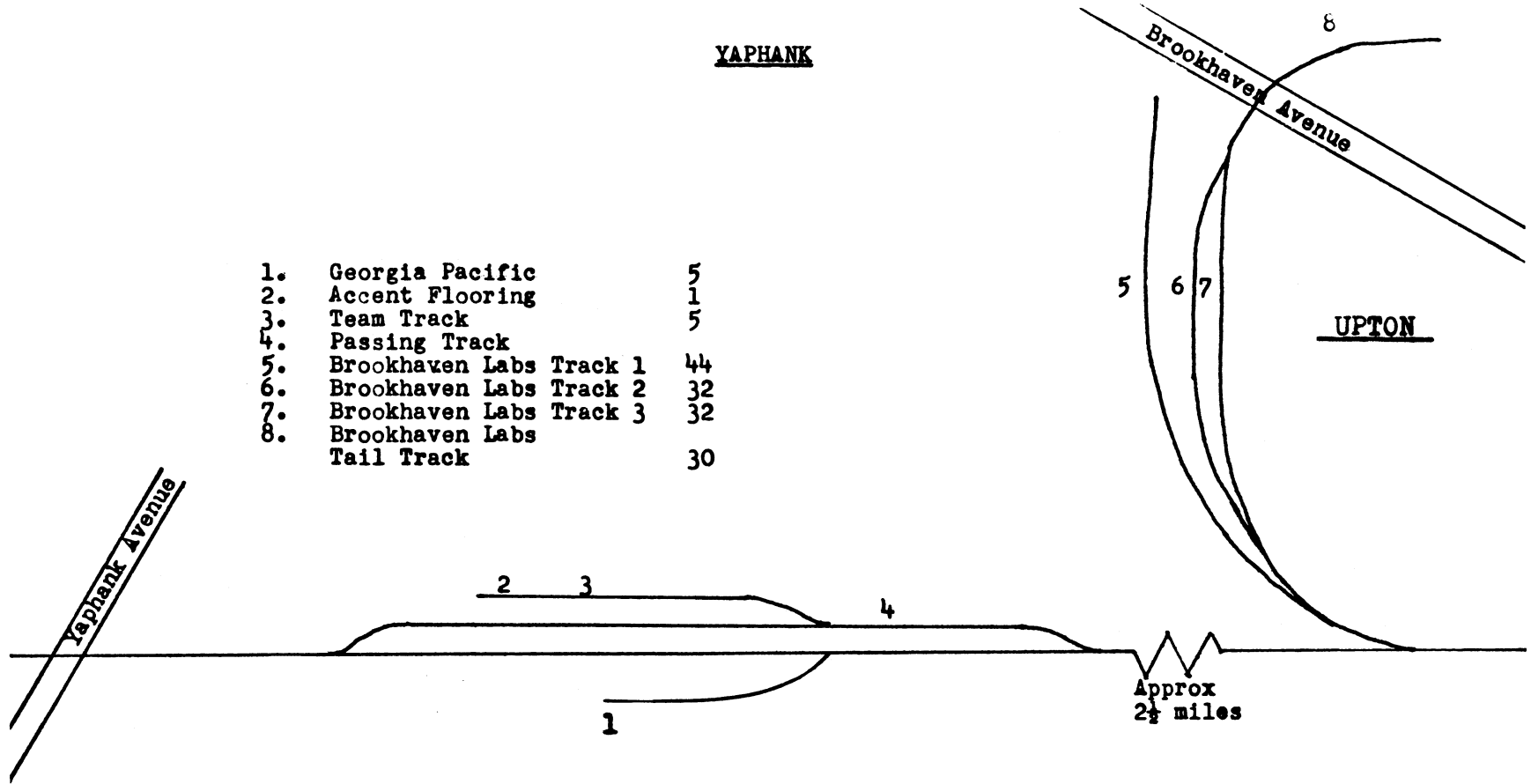

CALVERTON

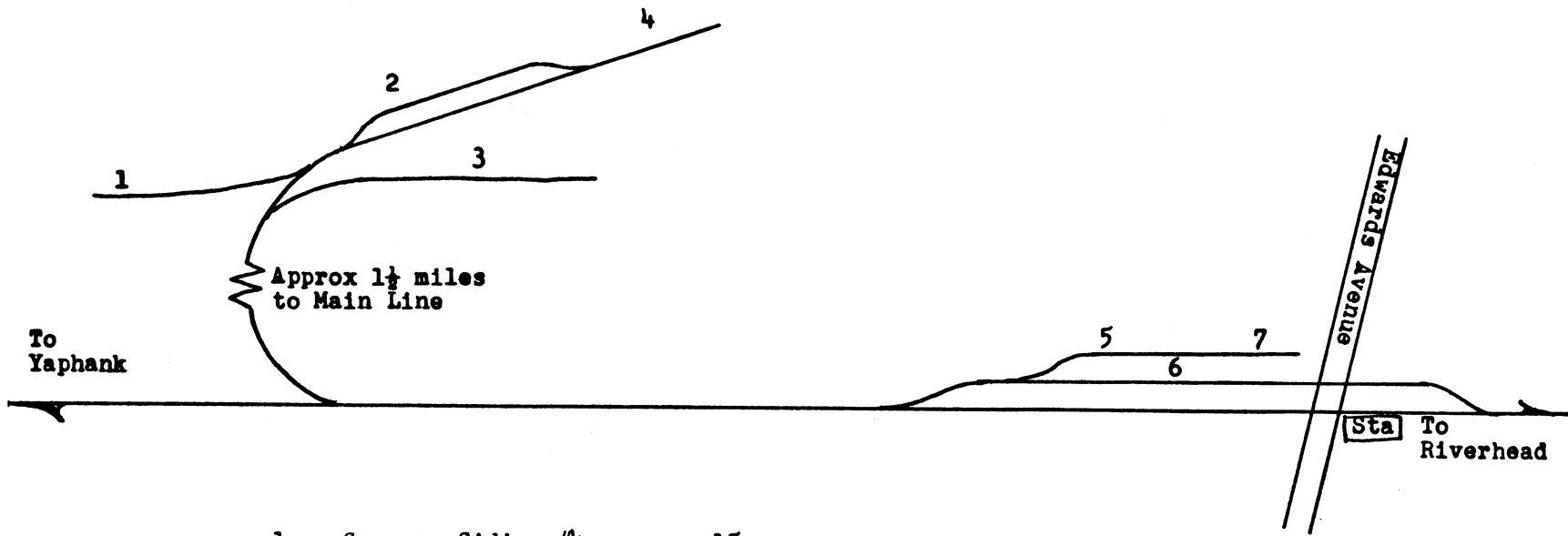

- | | | |
|----|---------------------|----|
| 1. | Grumman Siding #4 | 15 |
| 2. | Grumman Siding #2 | 15 |
| 3. | Grumman Siding #3 | 25 |
| 4. | Grumman Siding #1 | 32 |
| 5. | Team Track | 20 |
| 6. | Passing Track | 34 |
| 7. | Long Island Produce | 10 |

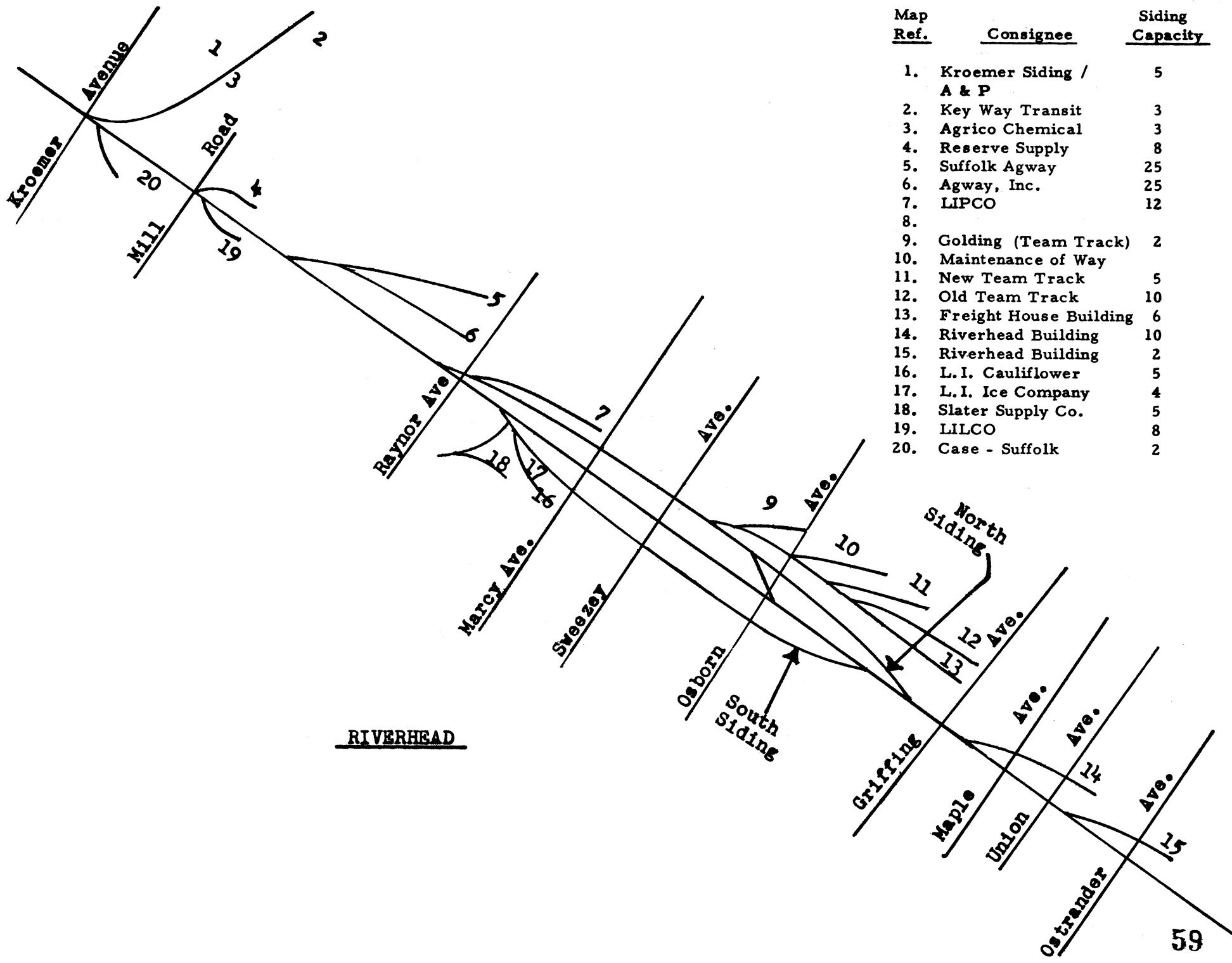

Map Ref.	Consignee	Siding Capacity
1.	Kroemer Siding / A & P	5
2.	Key Way Transit	3
3.	Agrico Chemical	3
4.	Reserve Supply	8
5.	Suffolk Agway	25
6.	Agway, Inc.	25
7.	LIPCO	12
8.		
9.	Golding (Team Track)	2
10.	Maintenance of Way	
11.	New Team Track	5
12.	Old Team Track	10
13.	Freight House Building	6
14.	Riverhead Building	10
15.	Riverhead Building	2
16.	L. I. Cauliflower	5
17.	L. I. Ice Company	4
18.	Slater Supply Co.	5
19.	LILCO	8
20.	Case - Suffolk	2

RIVERHEAD

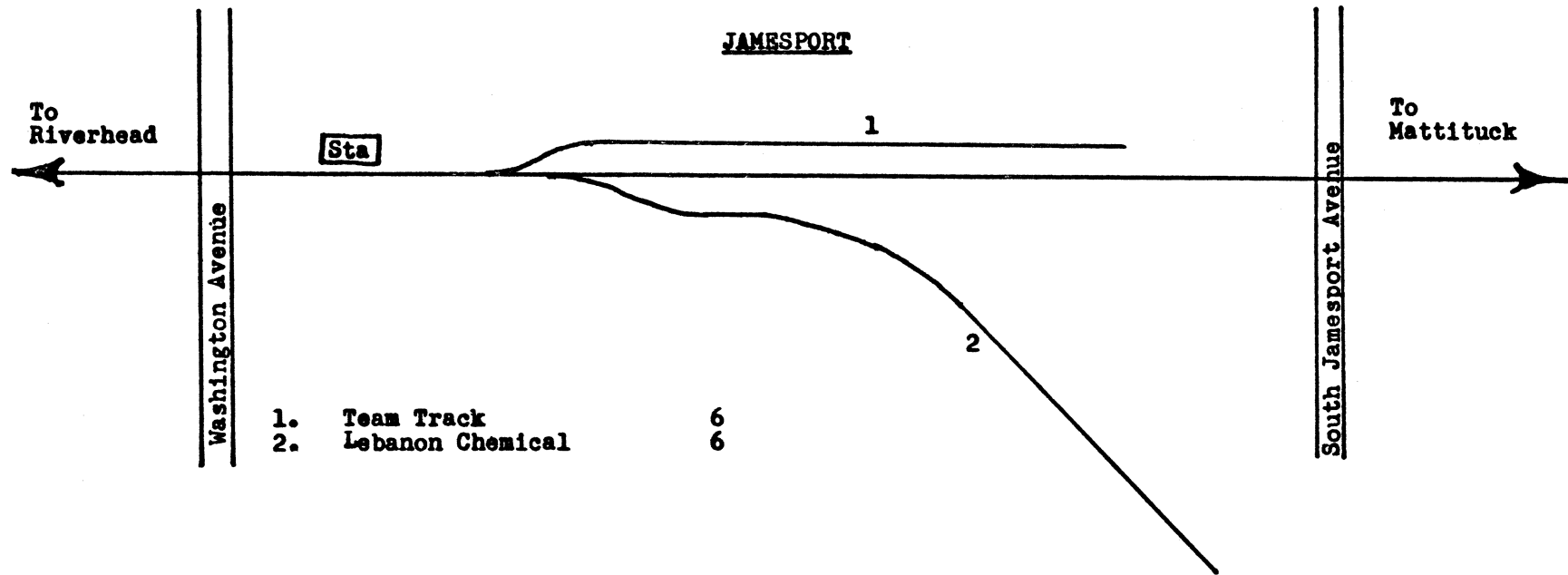

- | | | |
|----|------------------|---|
| 1. | Team Track | 6 |
| 2. | Lebanon Chemical | 6 |

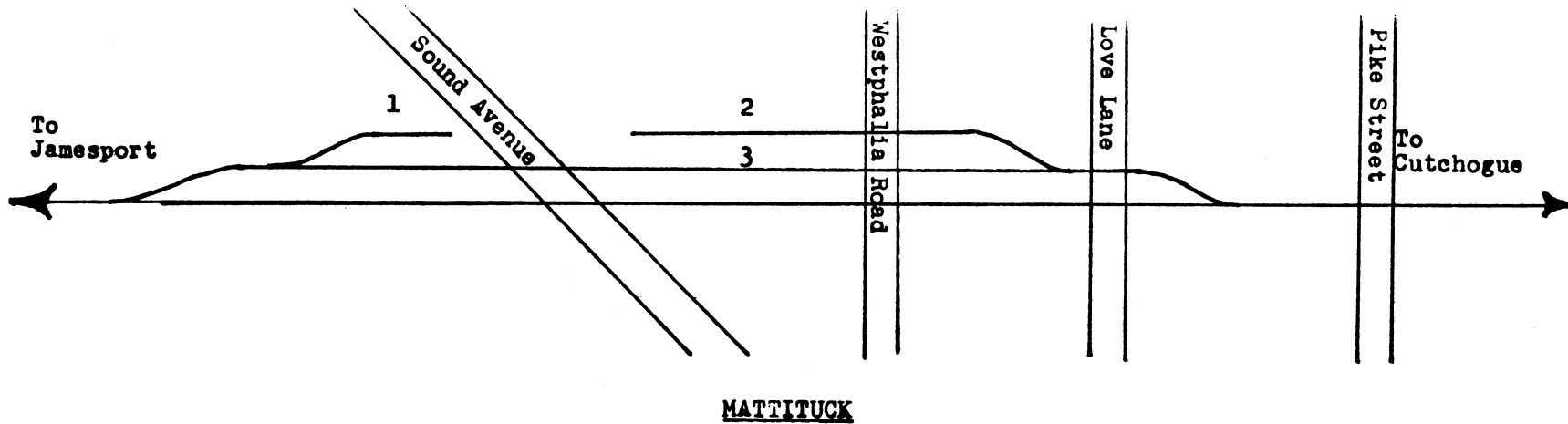

1.	Schulman	4
2.	Team Track	10
3.	Passing Siding	23

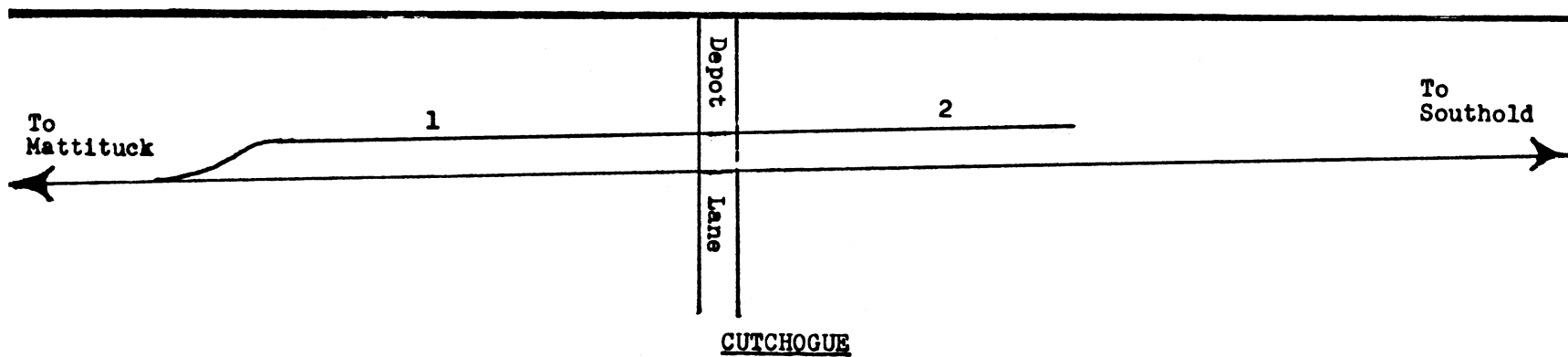

1.	Pollack	7
2.	Team Track	6

Note: This station open February 15 thru April 15 yearly

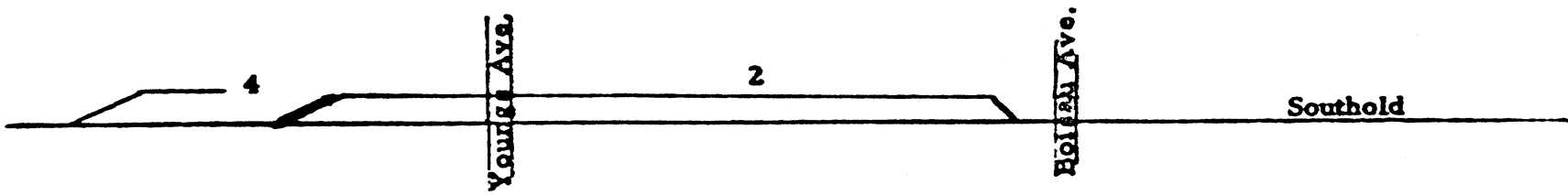

2. Team Track - 13

4. L.I.P. - 3

SOUTHOLD